

# PCA II Pump Operator's Manual

***Baxter***

Baxter Healthcare Corporation  
Deerfield, IL 60015-4633

5382036 Rev. 8/97

©1993 Baxter Healthcare Corporation. All rights reserved.



To Purchase, Visit [Avobus.com](http://Avobus.com) or call [1-800-674-3655](tel:1-800-674-3655)

11  
12  
13  
14  
15  
16  
17  
18  
19  
20  
21  
22  
23  
24  
25  
26  
27  
28  
29  
30  
31  
32  
33  
34  
35  
36  
37  
38  
39  
40  
41  
42  
43  
44  
45  
46  
47  
48  
49  
50  
51  
52  
53  
54  
55  
56  
57  
58  
59  
60  
61  
62  
63  
64  
65  
66  
67  
68  
69  
70  
71  
72  
73  
74  
75  
76  
77  
78  
79  
80  
81  
82  
83  
84  
85  
86  
87  
88  
89  
90  
91  
92  
93  
94  
95  
96  
97  
98  
99  
100

101  
102  
103  
104  
105  
106  
107  
108  
109  
110  
111  
112  
113  
114  
115  
116  
117  
118  
119  
120  
121  
122  
123  
124  
125  
126  
127  
128  
129  
130  
131  
132  
133  
134  
135  
136  
137  
138  
139  
140  
141  
142  
143  
144  
145  
146  
147  
148  
149  
150  
151  
152  
153  
154  
155  
156  
157  
158  
159  
160  
161  
162  
163  
164  
165  
166  
167  
168  
169  
170  
171  
172  
173  
174  
175  
176  
177  
178  
179  
180  
181  
182  
183  
184  
185  
186  
187  
188  
189  
190  
191  
192  
193  
194  
195  
196  
197  
198  
199  
200

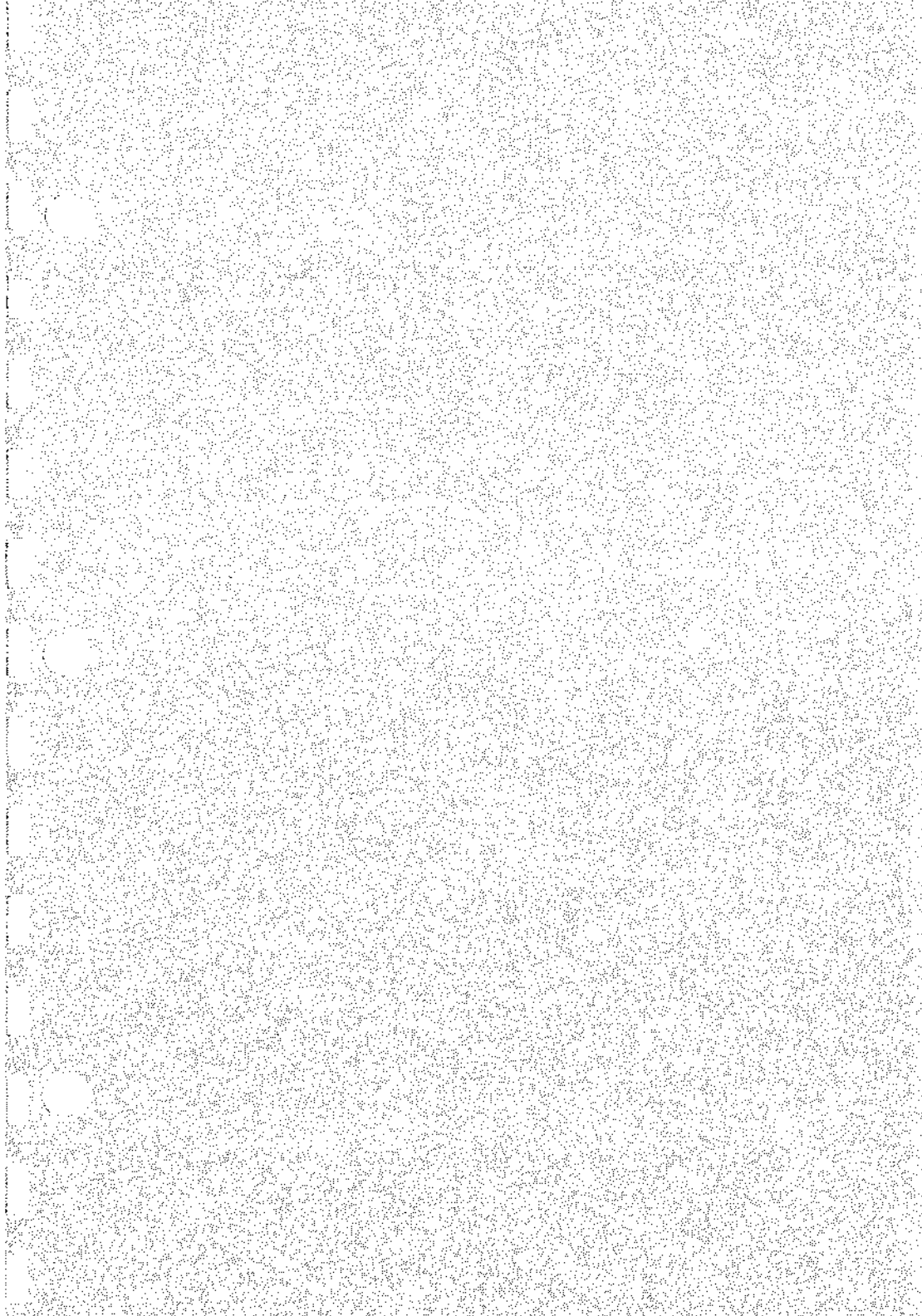

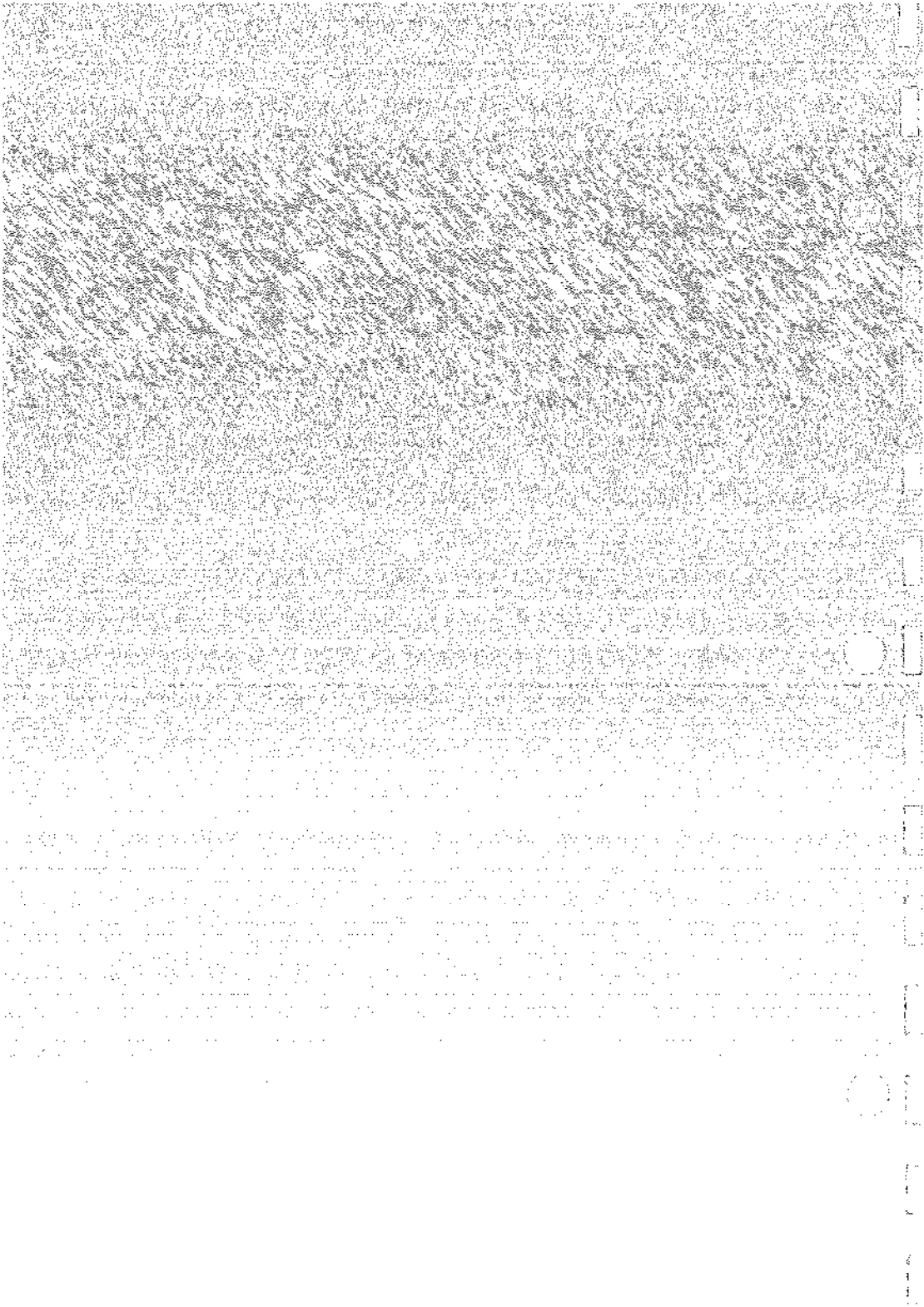



## Preface

This manual describes how to set up the PCA II Pump (Catalog number 2L3104), perform routine maintenance, and set up the printer. It also includes information about the AC Power Kit (Catalog number 2L3213).

For detailed information about using a cartridge in the PCA II Pump, see the operator's manual that was issued with the cartridge.

### WARNING



*An issued or revision date for these instructions is included for the user's information. If a period of two years has elapsed between this date and product use, the user should contact Baxter Anesthesia to learn if additional product information is available.*

*Use only under the direction of a qualified physician. Hospital protocol for management of drugs to be used must be followed with this device.*

*Federal law (USA) restricts this device to sale by or on the order of a physician.*



## Contents

Introducing the PCA II Pump .....	1-1
Components .....	1-2
PCA II Pump Controls and Indicators .....	1-3
Items Needed to Set Up the Pump .....	2-1
Setting Up the Pump .....	2-2
Inserting Batteries into the Pump .....	2-3
Attaching the Pump to the IV Pole .....	2-4
Attaching the Patient Switch .....	2-5
Preparing the Syringe .....	2-6
Preparing the Tubing Set .....	2-6
Installing the Syringe .....	2-7
Installing a Cartridge .....	2-10
Turning the Power On .....	2-12
Priming the Tubing Set .....	2-14
Entering the Prescription .....	2-15
Setting Up the Printer .....	2-16
The AC Power Kit .....	3-1
Setting Up the AC Power Kit .....	3-1
Operating Notes .....	3-3
Repair and Troubleshooting of the AC Power Kit .....	3-4
Routine Maintenance of the PCA II Pump .....	4-1
Replacing the Batteries .....	4-2
Cleaning and Disinfecting .....	4-3
Lubrication .....	4-3
Service Checks .....	4-4
Power-up .....	4-5
Attention light .....	4-5
Pusher block .....	4-5
Syringe holder .....	4-7
Repair and Troubleshooting of the PCA II Pump .....	5-1
PCA II Pump Specifications .....	6-1
Definitions .....	6-2
Warnings .....	6-3
Requesting Additional Information .....	6-5
Infusion Pump Tracking .....	6-6
Index .....	I-1



PCA II Pump and AC Power Kit Warranty

**List of Figures**

Figure 2-1 • Battery compartment ..... 2-3

Figure 2-2 • Attaching the pump to the IV pole clamp .... 2-4

Figure 2-3 • Sliding the pusher block to the top of the  
syringe holder ..... 2-7

Figure 2-4 • Placing the syringe into the holder ..... 2-8

Figure 2-5 • Latching the pusher block to the syringe  
plunger flange ..... 2-9

Figure 2-6 • Installing a cartridge ..... 2-11

Figure 2-7 • Printer dip switch settings ..... 2-16

Figure 3-1 • Connecting the charger to the pump ..... 3-2

Pump components— unfold last page and use while following  
instructions throughout the manual

0

0



0

0

0

0

0



0

0

0

0

0

0

0

0



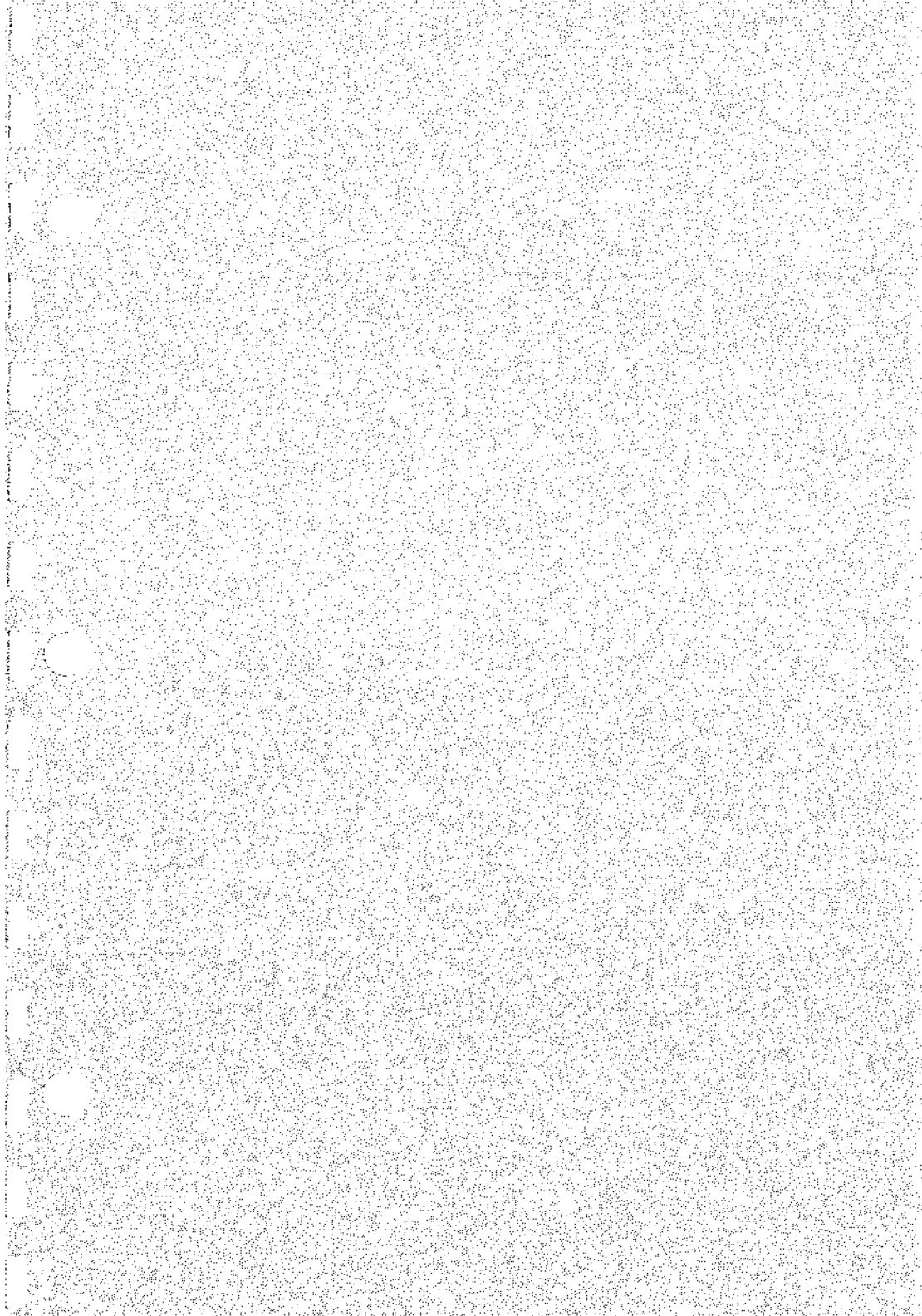

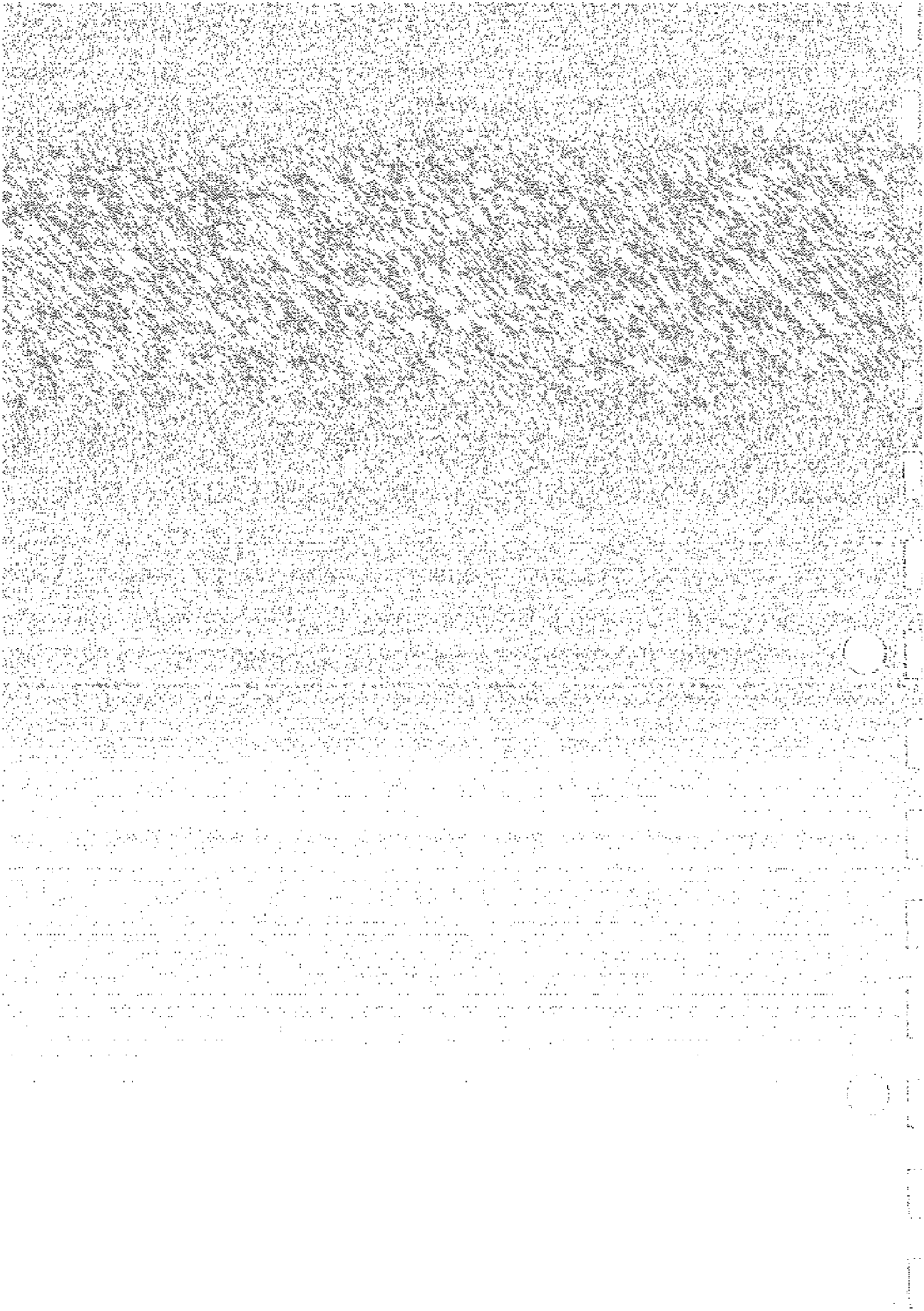

To Purchase, Visit [Avobus.com](http://Avobus.com) or call [1-800-674-3655](tel:1-800-674-3655)

## Introducing the PCA II Pump

The PCA II Pump is a syringe infusion pump capable of both continuous and intermittent infusion of parenteral fluids in a hospital setting. The pump can be used with or without a primary IV delivery system. The pump uses state of the art microprocessor electronics for control of all functions. Cartridges, available separately, allow the pump operator to change the characteristics of the pump. The operation of PCA II Pump controls depends upon the cartridge installed in the pump.

The pump drive mechanism consists of a DC motor, gear train, precision lead screw, pusher block, and syringe retention device. It is powered by four D-size alkaline batteries or the optional AC power kit.

The constant monitoring of pump performance results in optimal safe operation. Sophisticated hardware and software that can stop the pumping action and signal the operator help prevent faulty operation due to low flow, runaway, excess pressure, low battery, or control circuit failure. In addition, the prescription can be changed only after an authorized user enters a preassigned access code.

### WARNING



*The PCA II Pump may malfunction if used near electric fields, magnetic fields, or radiation sources, such as electrosurgical units, magnetic resonance imaging machines, or x-ray machines.*

*This equipment is not suitable for use in the presence of flammable anesthetics of air/oxygen or nitrous oxide.*

*For additional information, contact your Baxter Anesthesia Division sales representative.*



## Components

The PCA II Pump has the following components:

- Front panel with buttons, lock, and indicator lights
- Syringe cover
- Syringe holder
- ON and OFF buttons: inside syringe cover
- Cartridge connection point: inside syringe cover
- Battery compartment door: at base of pump
- Patient switch connection point: at base of pump
- Printer connection point: at left side of pump
- AC adapter connection point: at left side of pump
- Pole connection point: on back of pump

*Refer to the pull-out illustration of the pump at the end of this manual to help locate the pump components.*

The front panel of the pump includes a display that shows messages during set up and operation of the pump, a numeric keypad, ENTER button, CLEAR button, START/STOP button, HISTORY button, Power light, Attention light, and key-operated cover lock. The patient switch, which connects by a cord to the pump, allows the patient to request an injection in the PCA and Basal/PCA modes by pushing the button.

Messages that appear during pump operation on the panel display help the operator set up and operate the pump. Messages also provide detailed information about alarm and status conditions.

The Attention light on the front panel alerts the operator to an incorrect operating condition.



## PCA II Pump Controls and Indicators

ON button	Turns on the pump power.
OFF button	Turns off the pump power.
Number and decimal keys	Allows entry of numeric data, such as prescription values, time, and date. Also, used to select numbered choices.
ENTER button	Records the displayed data into memory. Also, confirms a choice or entry of numerical data.
CLEAR button	Allows re-entry of data and silencing of audible tone.
START/STOP button	Starts or stops therapy in any operating mode.
HISTORY button	Recalls detailed patient history.
Power light	This flashing light shows that the power is on and the pump is operating.
Attention light	This flashing light warns the operator of an impending or currently incorrect operating condition. For more information, see the appropriate cartridge operating manual.
Syringe cover lock	This two position lock— Lock and Unlock— secures the syringe cover. The pump cannot be operated unless the syringe cover is closed and locked.

0

0



0

0

0

0

0



0

0

0

0

0

0



0

0

0

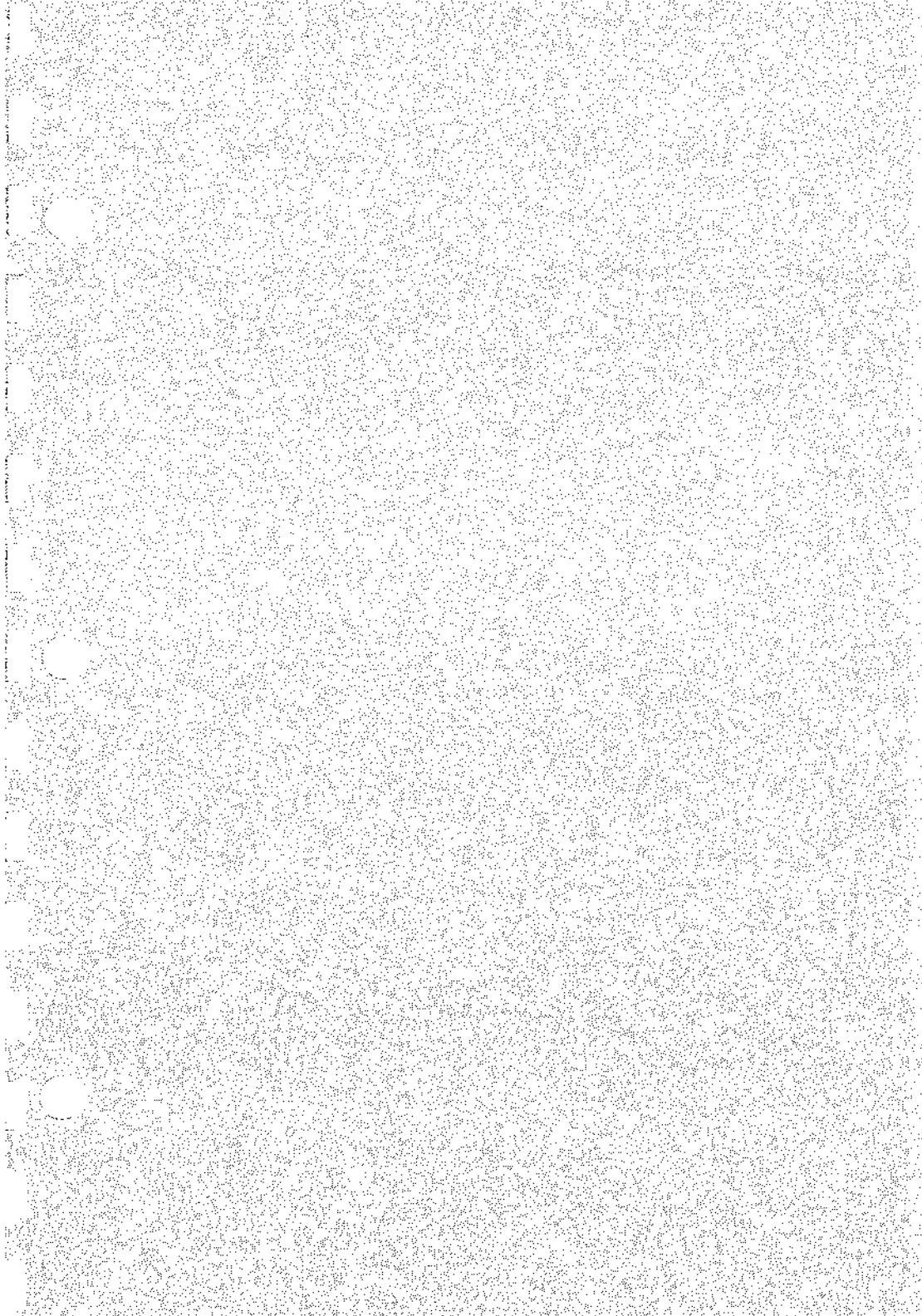

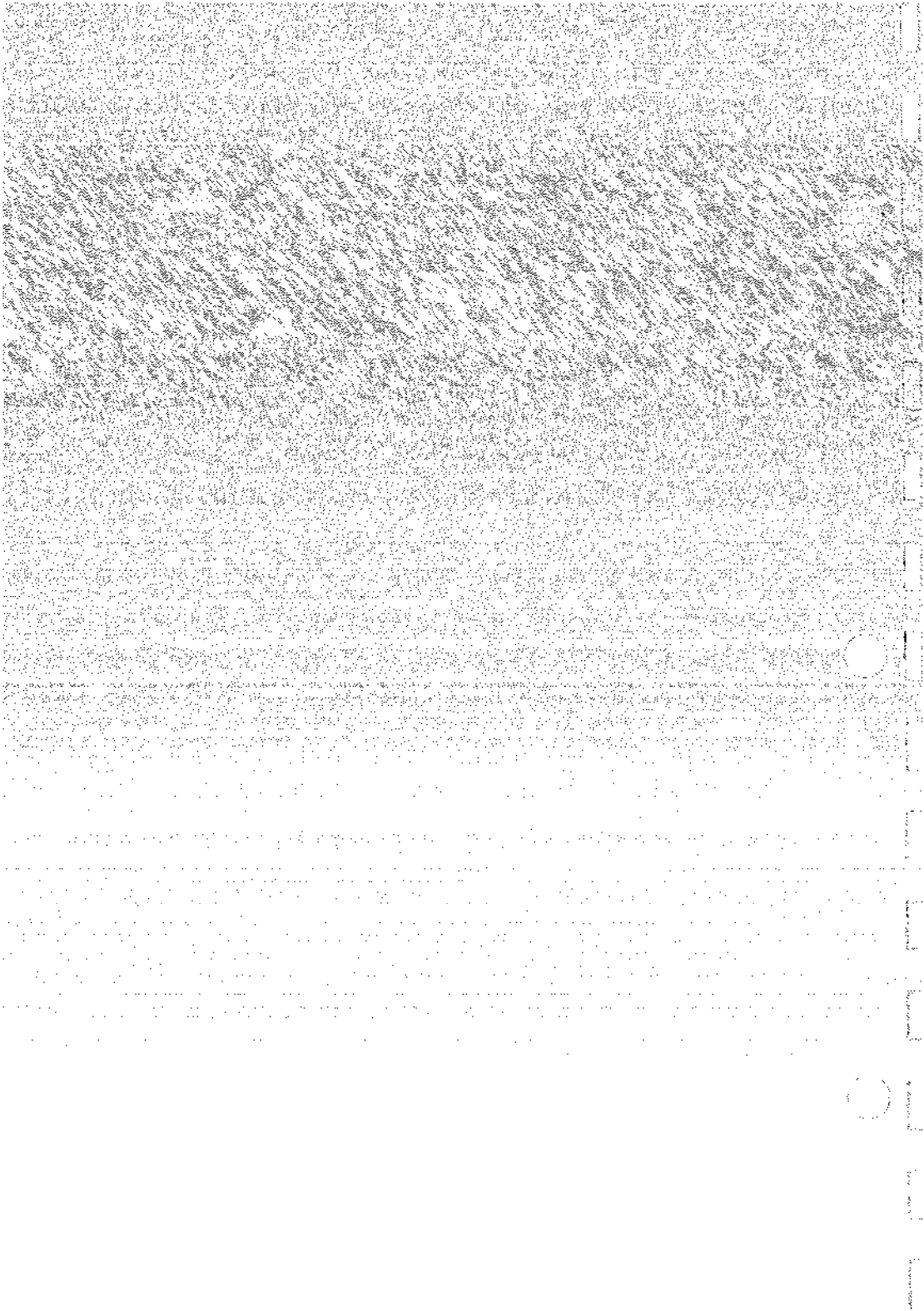





## Items Needed to Set Up the Pump

- PCA II Pump
- 4 D-cell alkaline batteries (or, optional AC power kit)
- Pole mounting clamp
- Patient switch (optional— for PCA and Basal/PCA operation only)
- Cartridge
- Key to unlock and lock the pump syringe cover
- Syringe (1)

50 mL Prefilled Syringe, or  
B-D® 60 mL plastic syringe, or  
Monoject® 60 mL plastic syringe

Use of any other syringe may result in inaccurate delivery.

- Tubing set

Tamper-Resistant Extension Set

Anti-Siphon Set

Combination Y-Set

Prefill Combination Y-Set

*The use of these Baxter I.V. administration sets is strongly recommended.*

- Printer with adapter, cables, and paper (optional— for printing patient history)

B-D is a registered trademark of Becton Dickinson and Company.  
Monoject is a registered trademark of Sherwood Medical, Inc.

## Setting Up the Pump

Pump setup includes the following steps, each of which is explained in detail below.

- Inserting batteries into the pump
- Attaching the pump to the IV pole
- Attaching the patient switch
- Preparing the syringe
- Preparing the tubing set
- Installing the syringe
- Installing a cartridge
- Turning the power on
- Priming the tubing set
- Entering the prescription

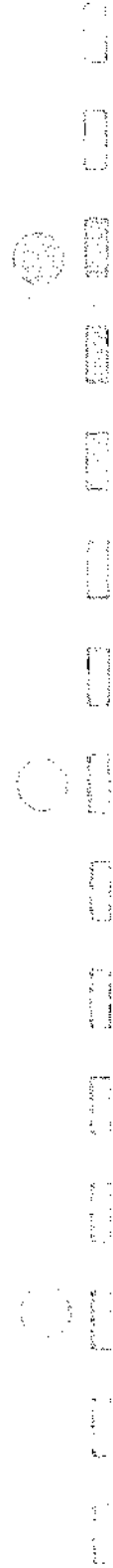

## Inserting Batteries into the Pump

The pump requires 4 D-cell alkaline batteries, or the optional AC power kit.

*For detailed information about operating the AC Power Kit, refer to The AC Power Kit section in this manual.*

To insert the batteries:

- Turn the pump upside down, as shown in Figure 2-1.

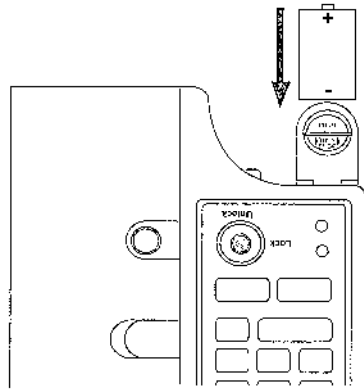

*Figure 2-1 • Battery compartment*

- Push in and slide open the battery compartment cover.
- Insert the batteries with positive ends toward the opening.
- Close the compartment cover by pushing it in and sliding it under the edge of the pump case.

<p>IMPORTANT</p> 	<p><i>Improper installation of batteries may cause batteries to leak.</i></p>
--	---

### Attaching the Pump to the IV Pole

The pump is designed to be attached to an IV pole. Use the clamp to attach the pump to the IV pole, as follows.

- Attach the clamp to the pump:

*Make sure the arrow on the clamp is pointing upwards, as shown in Figure 2-2.*

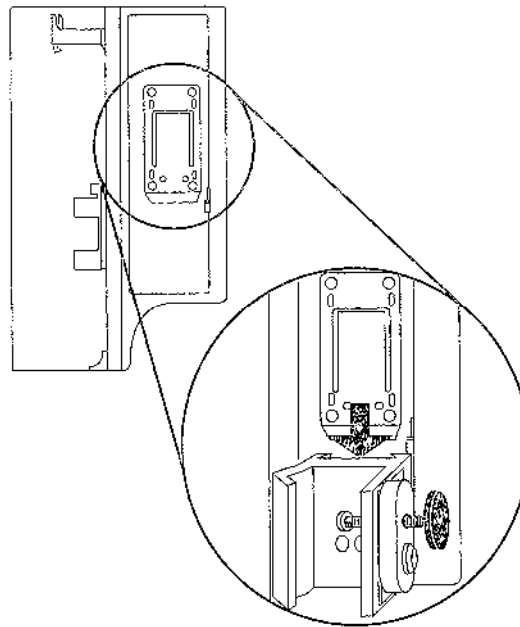

*Figure 2-2 • Attaching the pump to the IV pole clamp*

- Align the IV pole mounting clamp with the slide bracket on the back of the pump.
- Slide the clamp toward the top of the pump until the pump can go no further.
- To attach the clamp permanently to the pump, insert the two screws—supplied with the pump—through the clamp into the holes in the bracket.
- Mount the IV pole clamp to the IV pole or to a rail ranging from 1/2-inch to 1 1/4-inch in diameter and tighten it.

- To lock the IV pole clamp: insert, then push and rotate the key clockwise to the LOCK position. When the clamp is locked it can be tightened, but it cannot be loosened enough to remove the pump from the IV pole.

<b>IMPORTANT</b> 	<i>The pump must be inserted into the IV pole clamp BEFORE locking the clamp. Failure to do so allows the pump to be removed from the clamp without using the key.</i>
---	--

For more information, see the instructions packed with the clamp.

#### Attaching the Patient Switch

In PCA and Basal/PCA modes, the patient presses the button on the patient switch to request a dose. The patient switch is not needed for the Continuous Infusion Mode.

- Align the red dot on the patient switch cable connector with the red dot on the socket on the underside of the pump.
- Push the connector into the socket.

### Preparing the Syringe

Only the following syringes fit properly into the syringe holder:

- 50 mL Baxter Prefilled Syringe
- B-D 60 mL plastic syringe
- Monoject 60 mL plastic syringe

<p><b>IMPORTANT</b></p> 	<p><i>Use of other syringes may cause incorrect flow rates and dosages and may cause damage to the pump.</i></p> <p><i>Dispose of used disposables properly.</i></p>
---	--

- Fill the syringe with infusate using accepted clinical practice.

### Preparing the Tubing Set

Use the following types of tubing sets with the PCA II Pump:

- Tamper-Resistant Extension Set
- Anti-Siphon Set
- Combination Y-Set
- Prefill Combination Y-Set

- Attach the tamper-resistant disk end of an appropriate disposable set to the syringe.

## Installing the Syringe

The syringe only fits into the syringe holder as follows.

- Squeeze the release lever, as shown in Figure 2-3, and slide the pusher block as far as possible to the top of the pump.

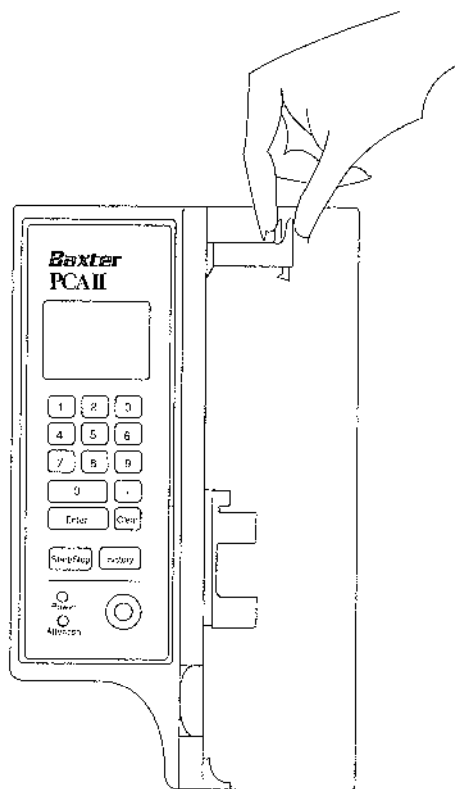

*Figure 2-3 • Sliding the pusher block to the top of the pump*

- Place the syringe barrel on the syringe holder making sure the barrel flange is aligned with the flange slot.

- Push the syringe into the holder. Make sure the syringe body is parallel to the pump, as shown in Figure 2-4.

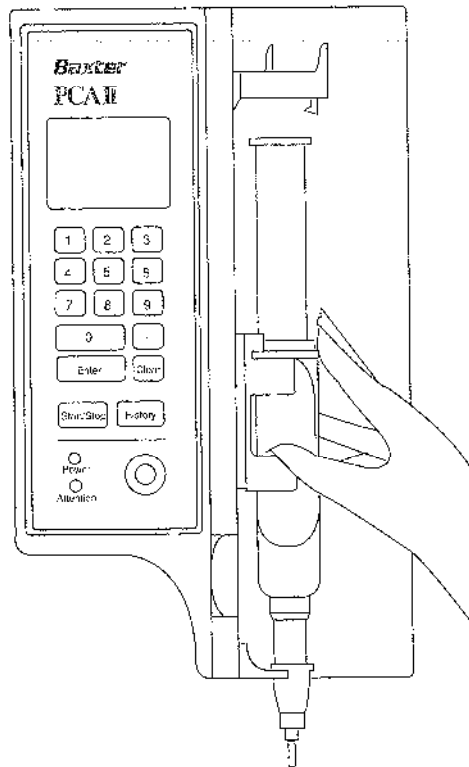

Figure 2-4 • Placing the syringe into the holder

**WARNING**



*Make sure the flange on the syringe barrel is properly placed in the slot of the syringe holder and the plunger flange is engaged by the anti-siphon latch, otherwise uncontrolled emptying of the syringe may occur. Uncontrolled emptying of the syringe may result in patient injury.*



- Squeeze the release lever and advance the pusher block until the latch grasps the syringe plunger flange and the pusher block presses firmly against the syringe plunger as indicated in Figure 2-5.

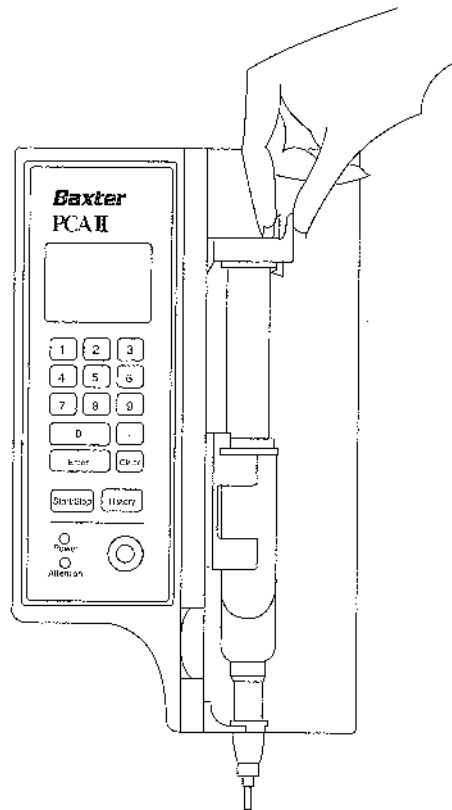



Figure 2-5 • Latching the pusher block to the syringe plunger flange

<p><b>WARNING</b></p> 	<p><i>Make sure the plunger flange is engaged by the anti-siphon latch, otherwise uncontrolled emptying of the syringe may occur. Uncontrolled emptying of the syringe may result in patient injury.</i></p>
---	--

### Installing a Cartridge

- If necessary, unlock the cover by pushing and turning the key counter-clockwise until it is at the UNLOCK position.
- Open the syringe cover.
- Remove the cartridge from the package.
- Align the cartridge with the rectangular opening inside the syringe cover at the top front corner of the pump. Make sure the label noting the cartridge name faces forward.
- Gently push the cartridge into the pump until it is firmly seated.

<p><b>IMPORTANT</b></p> 	<p><i>Do not force the cartridge into the opening; doing so may damage the pump and/or the cartridge.</i></p>
--	---

*Refer to the cartridge operator's manual for complete instructions.*

The edge of the cartridge label will be about 1/8-inch from the edge of the pump case, as shown in Figure 2-6.

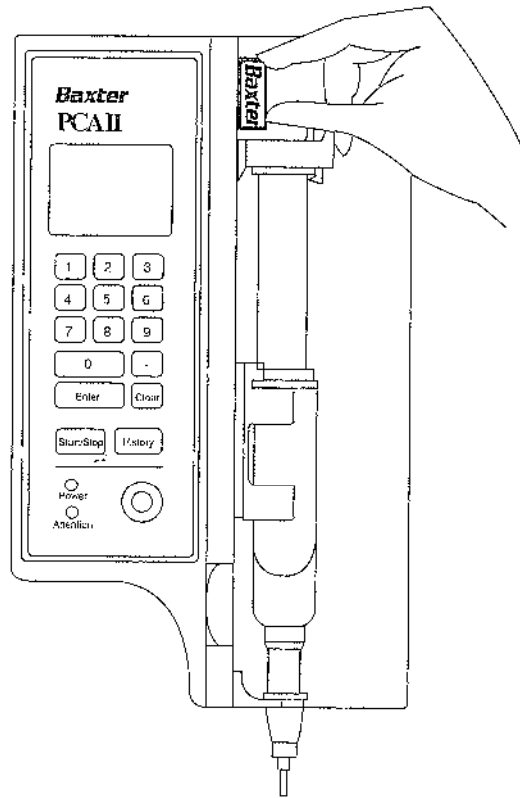
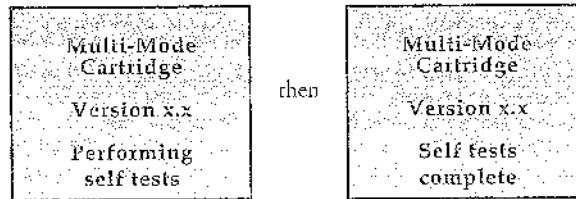

*Figure 2-6 • Installing a cartridge*

## Turning the Power On

- Press the green ON button inside the syringe cover.

The pump will sound a long beep, followed by a short one. After approximately six seconds, messages similar to the following will appear on the screen.



*If the pump does not start, check the batteries. If the pump beeps continuously, turn it off, reseat the cartridge, and restart the pump.*

The pump performs self tests, beeps three times, and then displays the cartridge identification and version number. A screen similar to the following appears.

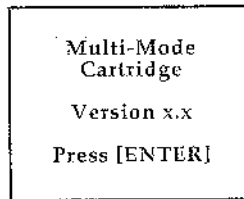

Under certain circumstances, the screen may have one of the following messages on the bottom line.

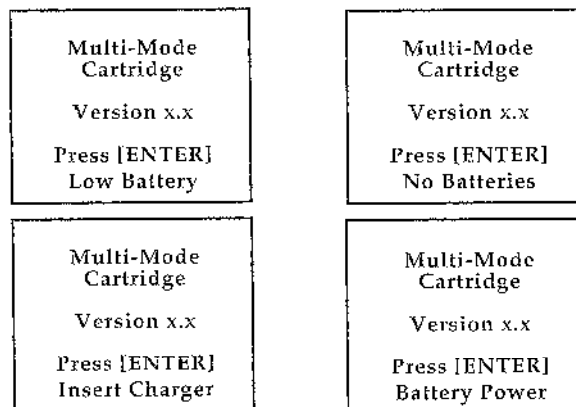

Refer to the Alarms and Warnings section of the cartridge manual for explanation of the Low Battery, No Batteries, Insert Charger and Battery Power messages.

- If the cartridge name on the screen is the same as the name on the cartridge label and is the desired cartridge, press ENTER. Otherwise, turn off the pump, remove the cartridge, and insert the correct one.

### Priming the Tubing Set

Prime the tubing set, as follows.

- With the cover open and unlocked, hold down the [1] key.

Press [1] to prime,  
or  
close and lock cover to continue.

The drive motor advances the syringe plunger for a maximum of 2 mL.

- Repeat until fluid appears at the end of the tubing set.

*Make sure all air is removed from the tubing set before attaching it to the patient. Refer to the instructions included with the tubing set for proper priming instructions.*

<p><b>WARNING</b></p> 	<p><i>When using a Prefilled Syringe, an appropriate Anti-Siphon Set or Prefill Combination Y-Set must be used. This will help prevent uncontrolled siphoning due to damage or incorrect placement of the Prefilled Syringe.</i></p> <p><i>When the PCA II Pump is used with a primary IV line, use of an appropriate Y-Set is highly recommended. Failure to properly use a Y-Set may result in retrograde analgesic flow into the primary line during a partial or complete downstream occlusion. This may subsequently result in inadvertent bolus to the patient when the occlusion is cleared.</i></p> <p><i>Use of an appropriate tubing set with a tamper resistant disk is highly recommended to ensure the integrity of the drug stored in the syringe.</i></p> <p><i>To reduce the risk of a bolus being infused after an occlusion has occurred, the pressure must be relieved by resetting the pusher block and/or disconnecting the system prior to freeing the occlusion. To minimize the bolus volume, use disposable sets specifically designed for PCA pumps.</i></p>
---	--

### Entering the Prescription

For instructions about entering the prescription, see the appropriate cartridge operator's manual.

---

### Notes

---

## Setting Up the Printer

The following items are needed to set up the printer:

- Seiko DPU-411 thermal printer (or equivalent serial printer)
- Printer Adapter
- 9-volt battery
- pump-to-adapter cable
- small screw driver
- thermal paper

*The Seiko printer has dip switches which must be set appropriately to operate with the PCA II Pump. See the Printer Adapter instructions for details.*

Set up the printer, as follows:

- Set the dip switches as shown in the top row of the label shown in Figure 2-7.

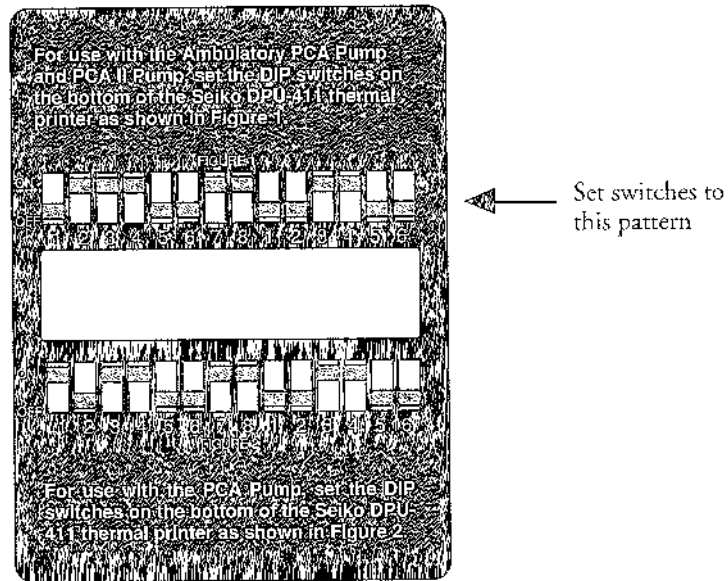

Figure 2-7 ◦ Printer dip switch settings

Only equipment complying with I.E.C. 601-1:1988 should be connected to the printer socket.



- Remove the battery door from the back of the printer adapter, attach the 9-volt battery, and replace the door.
- Attach the adapter-to-printer cable to the serial connector on the printer and tighten the screws.
- Attach the cables to the printer and to the PCA II Pump, as follows:
  - Connect the pump-to-adapter cable to the **pump** by lining up the red dots on the cable connector and the pump printer socket, and pushing in the connector.
  - Connect the pump-to-adapter cable to the **adapter** by lining up the red dots on the cable connector and the printer adapter socket, and pushing in the connector.
- Turn on the printer.
- If the printer's online light is not lit, press the ON LINE button.

*For information about inserting paper into and operating the printer, refer to the printer's operating manual.*

*For information about printing reports, see the appropriate cartridge operator's manual.*

THE  
EQUIPMENT  
RENTAL  
COMPANY  
OF  
THE  
UNITED  
STATES  
OF  
AMERICA



To Purchase, Visit [Avobus.com](http://Avobus.com) or call [1-800-674-3655](tel:1-800-674-3655)



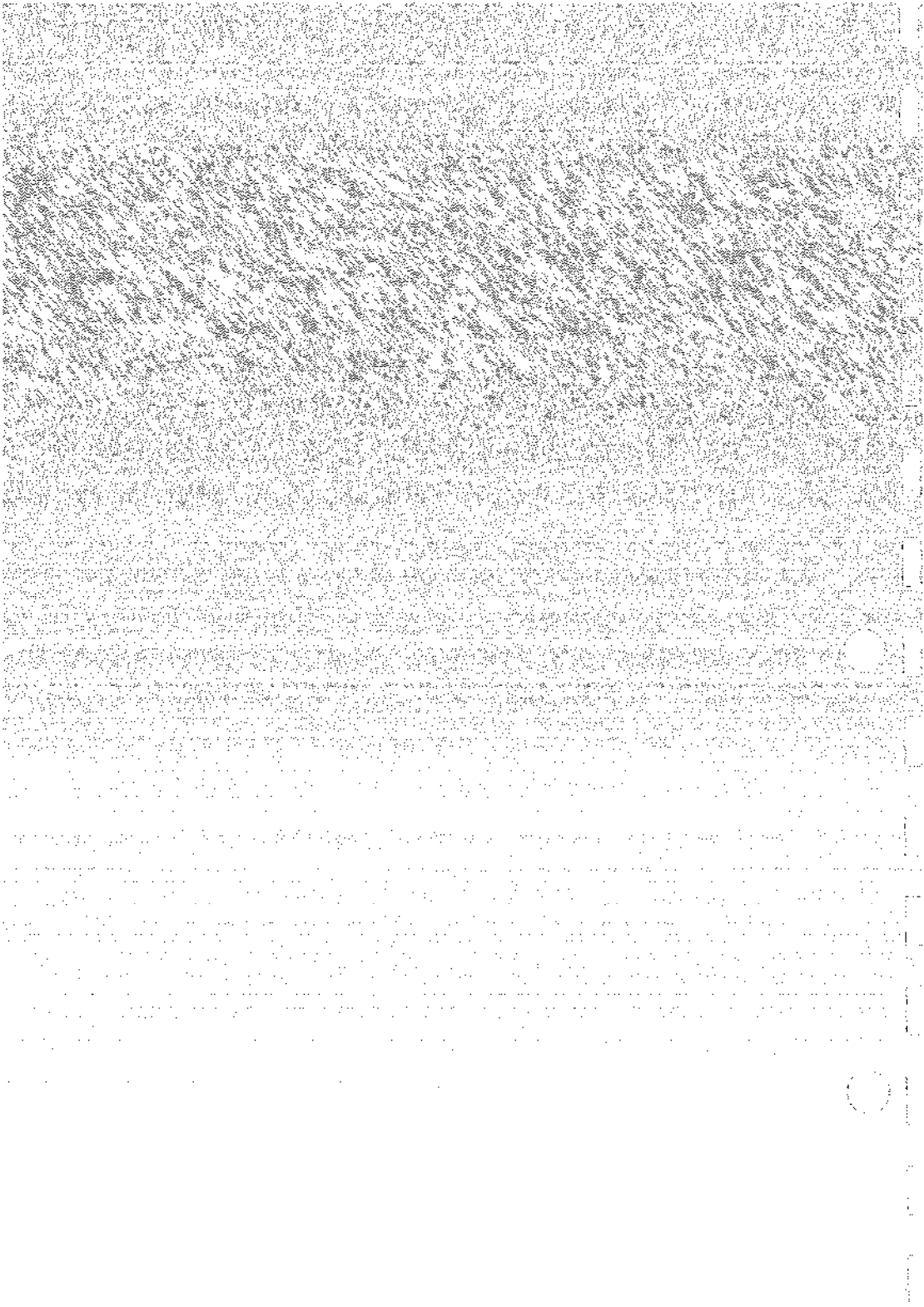

## The AC Power Kit

The AC Power Kit powers the PCA II Pump with AC power from a wall outlet; it is an alternative to using 4 D-cell alkaline batteries. The kit consists of:

- 1 AC charger
- 2 rechargeable nickel cadmium batteries

This section includes information about setting up the AC Power Kit, operating notes, a repair and troubleshooting guide, and AC Power Kit specifications.

### Setting Up the AC Power Kit

Setting up the AC Power Kit involves inserting the batteries, plugging the charger into the pump, and plugging the charger into a wall outlet, as described in detail below.

- Insert the rechargeable batteries into the pump, as follows.
  - Turn the pump upside down.
  - Push in and slide open the battery compartment cover.

<p><b>IMPORTANT</b></p> 	<p><i>If non-rechargeable batteries have been previously installed in the pump, they must be removed and replaced by the rechargeable nickel cadmium batteries.</i></p> <p><i>Do not mix rechargeable with non-rechargeable batteries under any circumstances. Doing so may result in damage to the pump.</i></p>
---	---

- Insert the rechargeable batteries with the positive end towards the open end of the battery compartment.
- Close the compartment cover.
- Attach the pump to the IV pole, if desired.

*For details about attaching the pump to the IV pole, see [Attaching the Pump to the IV Pole](#) in this manual.*

- Plug the charger into the pump, as shown in Figure 3-1.

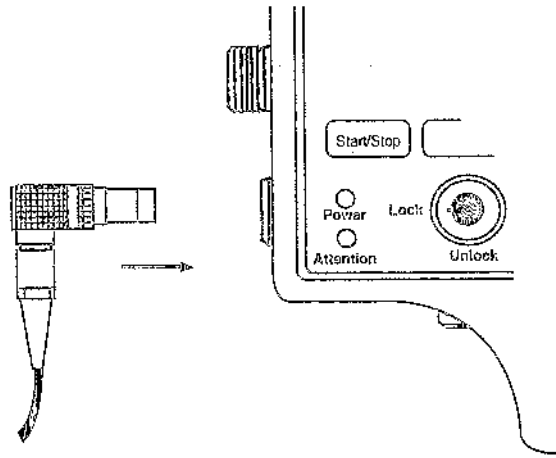

Figure 3-1 • Connecting the charger to the pump

- Remove the cover on the lower socket on the left side of the pump.
- Align the red dot on the right angle connector at the end of the charger cable with the dot on the socket.
- Push the connector into the socket.
- Plug the charger into the AC outlet.
- The batteries should be charged for 16 hours prior to initial use.

**IMPORTANT**



*A properly grounded electrical outlet must be used. Check with your Biomedical Engineering Department or hospital maintenance, if any questions arise.*

## Operating Notes

The pump should be connected to the charger whenever possible to keep the rechargeable batteries at full power. When the pump is to be temporarily disconnected from AC power, it is recommended that the charger be unplugged from the pump and left connected to the AC outlet.

The pump operates the same on either AC or DC power with the exception of the following messages.

### Battery Power

Whenever the pump switches to battery backup power— either as a result of unplugging the charger or a power failure— the pump will beep three times and display the **Battery Power** message. The message remains as long as the pump continues to draw power from the backup batteries, and the batteries are not running low on power.

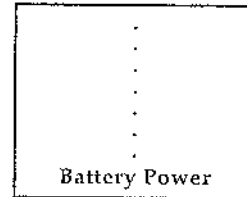

*If the Battery Power message appears unexpectedly, check to see if the charger unit has been accidentally disconnected from the AC outlet.*

### Insert Charger

If the rechargeable batteries start to run low, the pump will beep and display the **Insert Charger** message.

- Press CLEAR to temporarily silence the alarm.
- Plug in the charger as soon as possible.

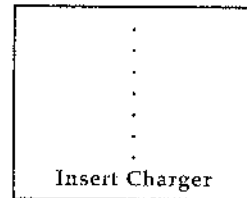

The pump will continue to operate for approximately 1 hour after the message first appears. The message remains on the screen as long as the pump continues to draw power from the backup batteries.

<p><b>IMPORTANT</b></p> 	<p><i>Failure to plug the charger in promptly once the Insert Charger message has appeared may result in an interruption in pump operation.</i></p>
---	---

**The AC Power Kit**

**No Batteries**

If there are no batteries in the pump while using the charger, the **No Batteries** message will be displayed. Rechargeable batteries should be inserted into the pump. Disconnecting the charger will result in termination of pump operation.

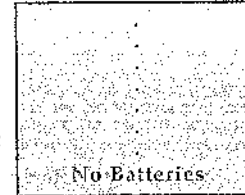

**Repair and Troubleshooting of the AC Power Kit**

Refer to the chart below for the problem and possible solution.

<p><b>IMPORTANT</b></p>	<p><i>There are no internal user repairable parts or adjustments. Contact your Baxter Anesthesia sales representative if the charger or rechargeable batteries fail.</i></p>
-------------------------	--

Problem	Possible Solution
<p>The <b>Battery Power</b> message remains when the charger is plugged in.</p>	<ul style="list-style-type: none"> <li>• Make sure the charger is properly connected to the pump.</li> <li>• Make sure the charger is plugged into the AC outlet.</li> <li>• Make sure the AC outlet has power.</li> <li>• Try the charger on another pump. If it fails on the pump that is known to operate properly, the charger should be replaced.</li> <li>• Try a different charger on the same pump. If the pump still does not operate properly, it should be returned for repair.</li> </ul>



Problem	Possible Solution
<p>The rechargeable batteries run out of power shortly after unplugging the charger.</p>	<ul style="list-style-type: none"> <li>• Make sure the batteries have been fully charged. The batteries should be charged for 16 hours prior to use.</li> <li>• Try using a different set of rechargeable batteries in the same pump. If a set of batteries known to be good fails, return the pump for service.</li> <li>• Try the batteries in another pump. If the batteries have the same problem after being charged in a pump that is known to operate properly, they should be replaced.</li> </ul>
<p>The pump works when the charger is plugged in, but shuts off as soon as the charger is unplugged.</p>	<ul style="list-style-type: none"> <li>• Make sure the batteries are installed correctly.</li> <li>• Test the batteries as explained above.</li> <li>• Make sure alkaline batteries are not being used instead of proper rechargeable batteries.</li> </ul>
<p><b>No Batteries</b> message appears when rechargeable batteries are installed in the pump.</p>	<ul style="list-style-type: none"> <li>• Ensure that rechargeable batteries are installed correctly.</li> <li>• Ensure that batteries are fully charged. Rechargeable batteries should be charged for 16 hours prior to initial use.</li> <li>• Test the batteries as explained above.</li> </ul>

THE UNIVERSITY OF CHICAGO LIBRARY

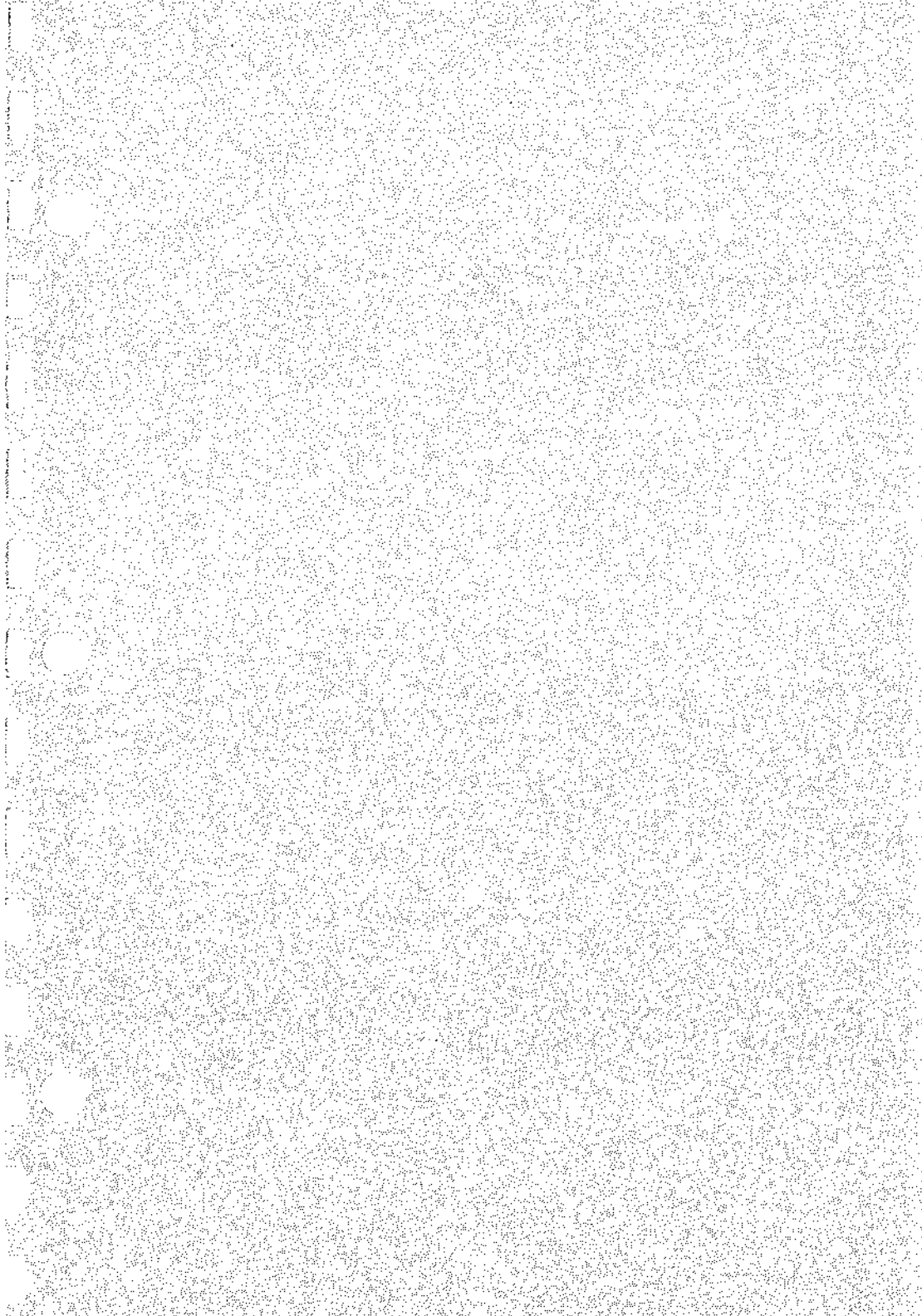

To Purchase, Visit [Avobus.com](http://Avobus.com) or call [1-800-674-3655](tel:1-800-674-3655)

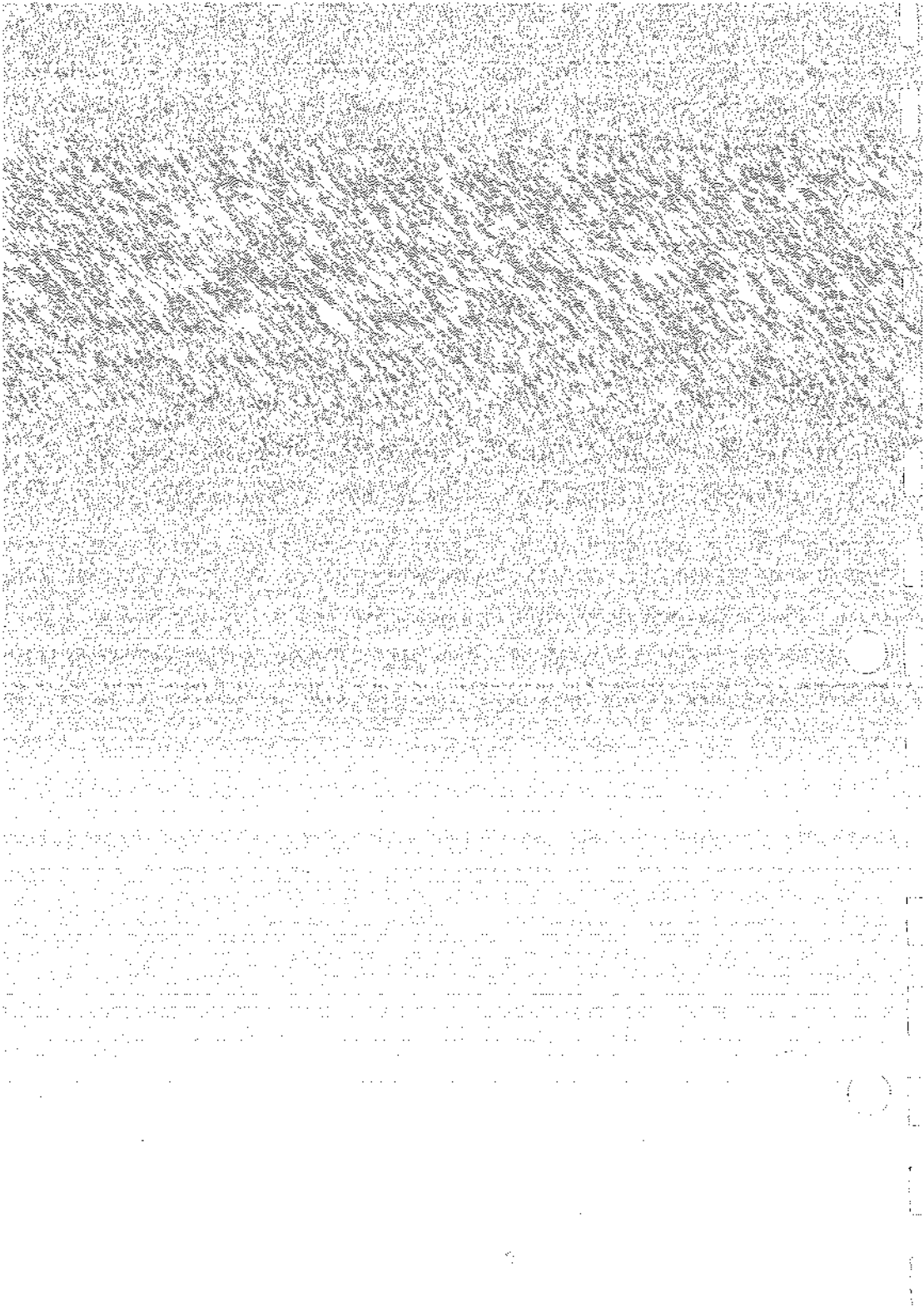

## Routine Maintenance of the PCA II Pump

The pump is designed to provide many years of reliable service with only minor routine maintenance. A functional inspection of the pump should be made every six months. At that time, we suggest changing the batteries (if using alkaline batteries), cleaning, disinfecting, and lubricating the pump, and performing the service checks described below.

The following subsections describe the routine maintenance techniques and service checks.

## Replacing the Batteries

<p>CAUTION</p> 	<p><i>Use only four D-size alkaline batteries (NEDA 13A). The batteries must be replaced within 8 hours of the first low battery alarm.</i></p> <p><i>Refer to the Cartridge Operator's Manual for more information on the low battery alarm sequence.</i></p>
--	--

*The pump can be powered by an optional AC power kit, instead of disposable batteries. Contact a Baxter Anesthesia sales representative for more information.*

To replace the batteries:

- Turn the pump off by pressing the OFF button located inside the syringe cover.
- Turn the pump upside down.
- Push in and slide open the battery compartment cover.
- Remove the old batteries.
- Insert the new batteries with the positive ends toward the opening.
- Close the compartment cover by pushing it in and sliding it under the edge of the pump case.
- The primary batteries should be removed from the equipment if it is not to be used for a lengthy period of time or placed in storage.

Make sure that the door comes back outward slightly as it latches.

When replacing batteries, history will be retained if new batteries are inserted within minutes of removal of the old ones.

### Cleaning and Disinfecting

The exterior surfaces may be cleaned using a cloth dampened with water or a mild detergent, then wiped dry. A mild germicide may be used as a disinfectant. Baxter Anesthesia recommends Vestal,<sup>®</sup> LPH<sup>®</sup> germicide, or equivalent.

<p>CAUTION</p> 	<p><i>The PCA II Pump is not waterproof and should not be immersed. Avoid getting liquids inside the pump or permanent damage may result. Do not use alcohol for cleaning. Sterilization by ETO, steam, or other method should not be attempted.</i></p>
--	--

The sets that are used in the PCA II pump are disposable and intended for single use only.

### Lubrication

The lead screw should be lubricated at least every six months using General Electric<sup>®</sup> Versilube<sup>®</sup> G-322L grease. Using the nozzle applicator supplied with the grease, squeeze a small amount onto the entire length of the lead screw. Do this by carefully inserting the nozzle straight into the case channel thereby spreading the rubber seal. Use care to avoid damaging the seal.

<p>CAUTION</p> 	<p><i>Use only the recommended lubricant. A substitute lubricant may cause permanent damage.</i></p>
--	--

Vestal and LPH are registered trademarks of Vestal Laboratories, Inc. a subsidiary of Chemed Corporation. General Electric and Versilube are registered trademarks of General Electric Company.



## Service Checks

The pump design includes extensive self-check procedures which continually monitor the pump operation. The user is usually unaware that these checks are being performed. Whenever a fault condition is detected, the appropriate alarm is triggered— visual and audible— and pump operation is halted until the error is corrected.

We recommend periodically performing the following tests:

- Power-up
- Attention light
- Pusher block
- Syringe holder

Refer to Cartridge Operator's Manual(s) for additional service checks.

*Make sure a cartridge is installed in the pump before starting the tests.*

### IMPORTANT



*No tests should be performed when the pump is connected to a patient.*

*If a pump fails a test, repeat the test twice.*

*If the pump still fails the test, call the Baxter Anesthesia Service Department for a service authorization number and the procedure for returning a pump for repair at 1-800-343-0366.*





**Power-up**

**Correct action:**  
The self-test message appears briefly and the pump beeps.

- Press the ON button.
- Check to make sure the cartridge is properly seated in its slot.
- If an electronic fault alarm appears, record the error number, (or, if the pump beeps continuously with no message) turn the pump OFF.
- Disconnect the pump from the patient and return the pump for service.

**Attention light**

**Correct action:**  
The red light flashes whenever a prescription has been entered and is not running or the syringe cover is open.

- Push and turn the key to the UNLOCK position.
- Open the syringe cover.
- If an electronic fault alarm appears, record the error number and turn the pump OFF.
- Disconnect the pump from the patient and return the pump for service.

**Pusher block**

**Correct action:**  
The syringe holder snugly holds a syringe. The pusher block moves freely over the complete travel range.

The anti-siphon latch of the pusher block captures the syringe plunger to prevent siphoning.

- Insert syringe in pump, but do not connect pusher block to syringe plunger.
- Close and lock the cover.
- Enter and verify the prescription.
- The Pusher block not connected message should appear.
- Unlock and open the cover.



**Pusher block, continued**

- Slide the release lever down until it snugly meets the top of the syringe plunger flange, as shown in the figure below.

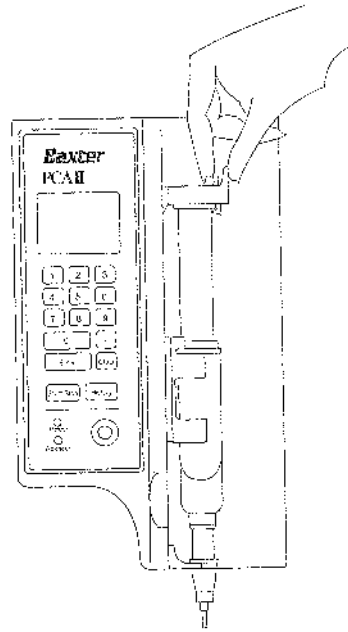

- Release the lever to engage the anti-siphon latch under the syringe plunger flange.
- Close and lock the cover.
- Verify the prescription and press START. The pump should begin running the entered prescription.
- If a problem occurs, return the pump for service.
- Unlock and open the cover, press OFF.

**Syringe holder**

Correct action:  
The syringe is held snugly  
by the holder.

- Make sure that a 60 mL plastic syringe or 50 mL prefilled syringe sits firmly in the holder, with the syringe barrel flange placed in the slot of the holder.
- If a problem occurs, return the pump for service.

C  
E  
P  
R  
E  
N  
T  
I  
O  
N  
A  
L  
T  
R  
I  
B  
U  
T  
E  
S



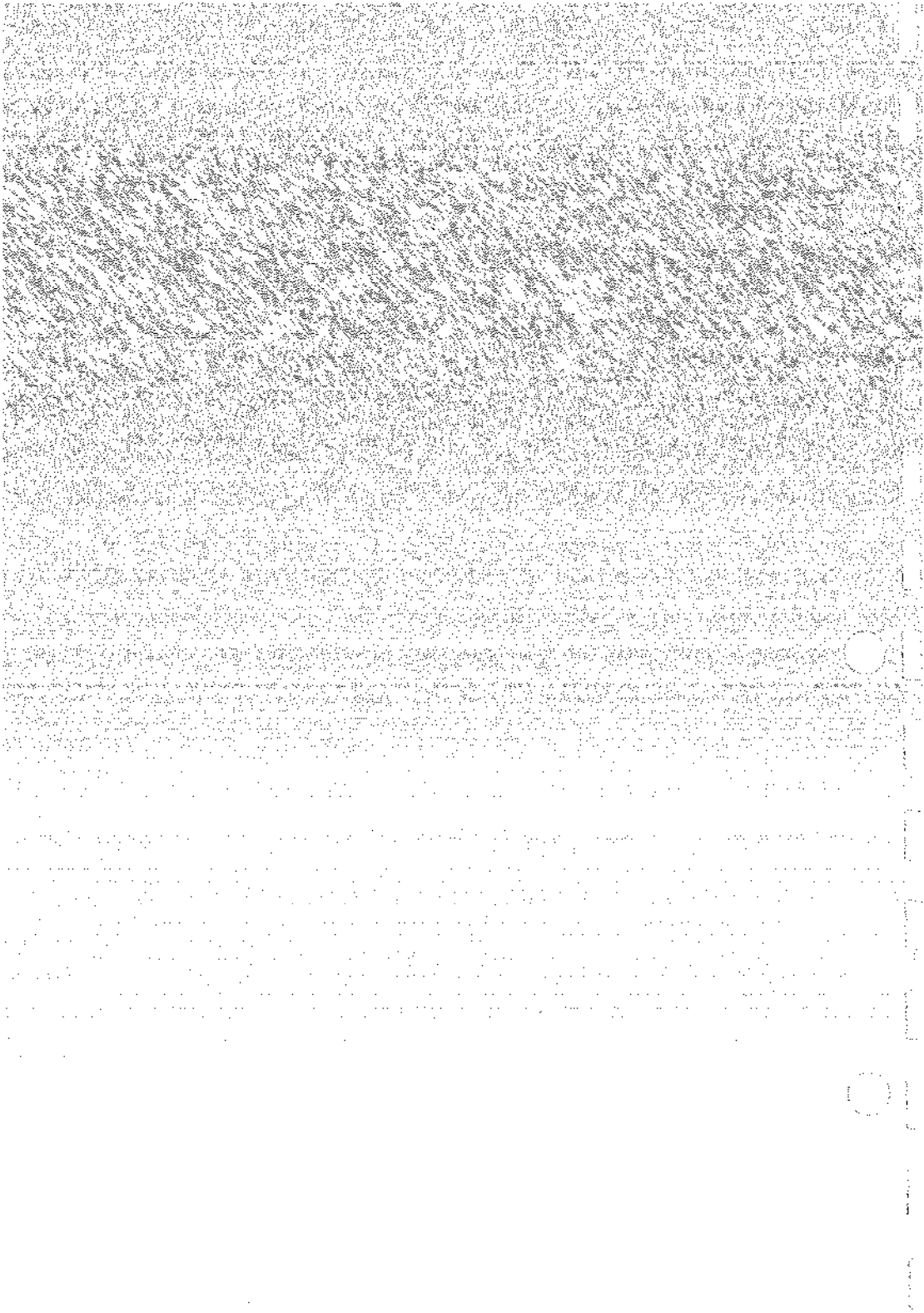

## Repair and Troubleshooting of the PCA II Pump

**WARNING**

*There are no internal user repairable parts or adjustments available. The pump should only be serviced by trained biomedical engineering technicians or Baxter Anesthesia's personnel.*

Since specialized equipment is necessary to adjust the mechanisms and electronics inside the pump, it is recommended that a defective unit be returned to the factory for troubleshooting and repair. When a pump is malfunctioning check that:

- the batteries are correctly placed— negative ends first,
- the batteries are not depleted, and
- the cartridge is correctly seated.

1  
2  
3  
4  
5  
6  
7  
8  
9  
10  
11  
12  
13  
14  
15  
16  
17  
18  
19  
20  
21  
22  
23  
24  
25  
26  
27  
28  
29  
30  
31  
32  
33  
34  
35  
36  
37  
38  
39  
40  
41  
42  
43  
44  
45  
46  
47  
48  
49  
50  
51  
52  
53  
54  
55  
56  
57  
58  
59  
60  
61  
62  
63  
64  
65  
66  
67  
68  
69  
70  
71  
72  
73  
74  
75  
76  
77  
78  
79  
80  
81  
82  
83  
84  
85  
86  
87  
88  
89  
90  
91  
92  
93  
94  
95  
96  
97  
98  
99  
100



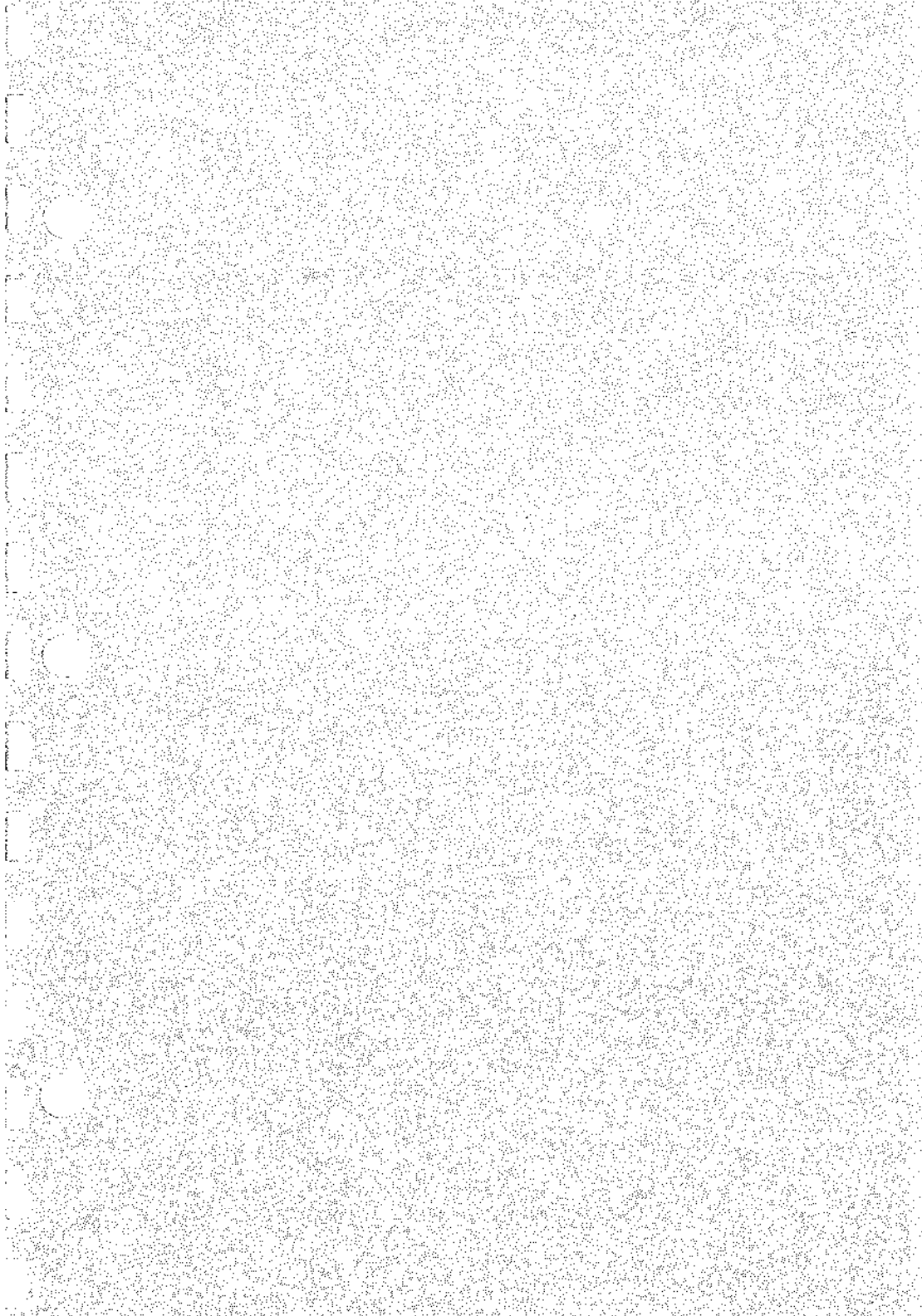

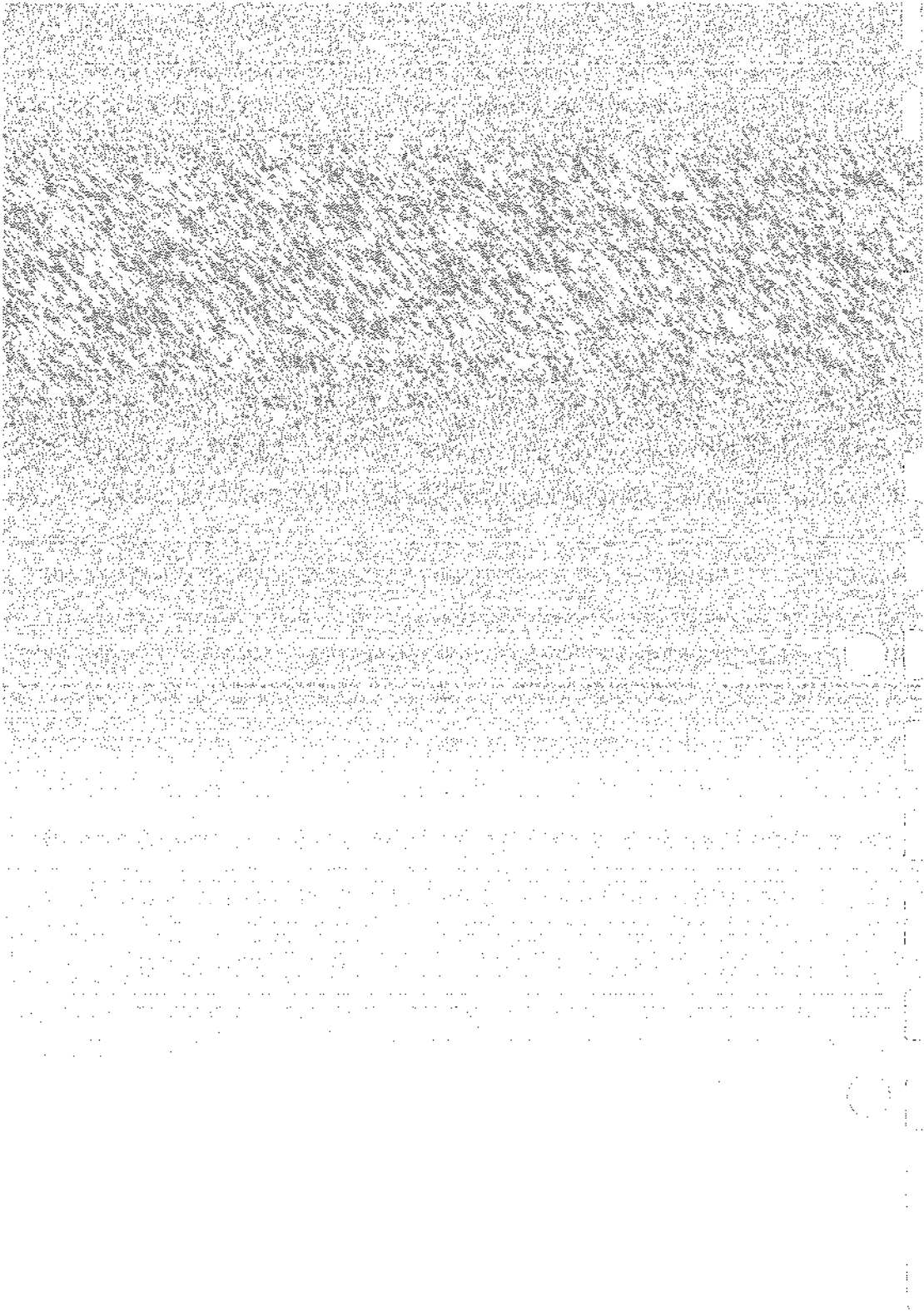





To Purchase, Visit [Avobus.com](http://Avobus.com) or call [1-800-674-3655](tel:1-800-674-3655)

## PCA II Pump Specifications

The PCA II is Type BF equipment using Class II or internal power source. Fluid Resistance IP x I.

Mode of Operation	<ul style="list-style-type: none"> <li>• PCA</li> <li>• Basal/PCA</li> <li>• Continuous</li> </ul>
Syringe Types	<ul style="list-style-type: none"> <li>• 50 mL Prefilled Syringe</li> <li>• Monoject, 60 mL plastic</li> <li>• B-D, 60 mL plastic</li> </ul>
Flow Rates	0.1 to 150 mL/hour, depending on the cartridge
Accuracy	<ul style="list-style-type: none"> <li>• Dose: <math>\pm 3\%</math> average linear displacement</li> <li>• Rate: <math>\pm 3\%</math> average linear rate</li> </ul>
Occlusion Force	$9.5 \pm 1.3$ pounds; equivalent to 11 psig nominal pressure
Front Panel Controls	<p>Scaled tactile and audible feedback membrane switches:</p> <ul style="list-style-type: none"> <li>• START/STOP</li> <li>• ENTER</li> <li>• HISTORY</li> <li>• CLEAR</li> <li>• 0-9 and decimal point</li> </ul> <p>ON and OFF switches inside the locking syringe cover.</p>
Security Features	<ul style="list-style-type: none"> <li>• Locking syringe cover with key lock</li> <li>• Lockable IV pole clamp</li> <li>• Cartridge contained within locking syringe cover</li> </ul>
Indicators	<ul style="list-style-type: none"> <li>• Description on the message panel: 8 lines x 14 characters each, alphanumeric LCD</li> </ul>
Batteries	<ul style="list-style-type: none"> <li>• Four D-size alkaline cells</li> <li>• Rechargeable</li> </ul>

**Specifications**

<b>Battery Life</b>	<ul style="list-style-type: none"> <li>alkaline: 600 hours typical (expected battery replacement period: 30 days)</li> </ul>
<b>Size</b>	<ul style="list-style-type: none"> <li>13.0 x 6.3 x 2.8 inches (330 x 160 x 71 mm)</li> </ul>
<b>Weight</b>	<ul style="list-style-type: none"> <li>4.2 pounds (1.9 kg) with batteries</li> </ul>
<b>Environmental Use &amp; Storage</b>	<ul style="list-style-type: none"> <li>Operational: 32° F to 122° F 0-90% rh (non-condensing)</li> <li>Non-operational: -4° F to 140° F 0-95% rh(non-condensing)</li> </ul>
<b>Options &amp; Accessories</b>	<ul style="list-style-type: none"> <li>Scilco DPU 411 Thermal Printer or equivalent</li> <li>Printer adapter and cable Tamper-Resistant</li> <li>Microbore Extension Sets 60" and 96"</li> <li>Microbore Anti-Reflux Y-Set</li> <li>Combination Y-Set 96"</li> <li>Anti-Siphon Extension Set for use with Prefilled Syringes</li> <li>Prefill Combination Y-Set for use with Prefilled Syringes</li> <li>Prefilled Syringe, 50 mL, Morphine Sulfate Injection, U.S.P., 1 mg/mL </li> <li>Morphine Sulfate Injection U.S.P., 1 mg/mL, 50 mL vial </li> <li>AC power kit</li> </ul>
<b>Definitions</b>	<p>Alternating Current </p> <p>Type BF </p> <p>Class II </p>

For use in the United Kingdom, the power kit is Power Pack Model Bax002E. Ordinary Fluid Resistance. Class II electrical power source, Input: 220:240VAC 50/60 HZ 18 W, Output: 7VDC +/- 0.5 V 400 ma MAX).

U.S. Patents 4,544,369; 4,804,368; 5,321,392; 5,256,157  
 Canada Patent 1,236,740  
 Australia Patent 572,182

## Warnings

An issued or revision date for these instructions is included for the user's information. If a period of two years has elapsed between this date and product use, the user should contact Baxter Anesthesia to learn if additional product information is available.

\* \* \*

Use only under the direction of a qualified physician. Hospital protocol for management of drugs to be used must be followed with this device.

\* \* \*

Federal law (USA) restricts this device to sale by or on the order of a physician.

\* \* \*

As with all medical electronic equipment, care must be exercised to avoid exposing this device to powerful sources of electromagnetic interference. Using the pump near operating equipment which radiates high energy radio frequencies (such as electrosurgical / cauterizing equipment, two-way radios, or cellular telephones) may cause false alarm conditions. If this happens, reposition the pump away from the source of interference; and restart the pump.

\* \* \*

This equipment is not suitable for use in the presence of flammable anesthetics.

\* \* \*

Make sure the flange on the syringe barrel is properly placed in the slot of the syringe holder and the plunger flange is engaged by the anti-siphon latch, otherwise uncontrolled emptying of the syringe may occur. Uncontrolled emptying of the syringe may result in patient injury.

\* \* \*

Use only recommended sets and syringes for best performance. Use of other syringes may cause incorrect flow rates and dosage.

\* \* \*

Make sure the plunger flange is engaged by the anti-siphon latch, otherwise uncontrolled emptying of the syringe may occur. Uncontrolled emptying of the syringe may result in patient injury.

\* \* \*

Improper installation may cause batteries to leak. Do not mix rechargeable with non-rechargeable batteries.

\* \* \*

 Specifications

When using a Prefilled Syringe, an appropriate Anti-Siphon Set or Prefill Combination Y-Set must be used. This will help prevent uncontrolled siphoning due to damage or incorrect placement of the Prefilled Syringe.

\* \* \*

The pump must be inserted into the I.V. pole clamp before locking the clamp. Failure to do so allows the pump to be removed from the clamp without using the key.

\* \* \*

When the PCA II Pump is used with a primary IV line, use of an appropriate Y-Set is highly recommended. Failure to properly use a Y-Set may result in retrograde analgesic flow into the primary line during a partial or complete downstream occlusion. This may subsequently result in inadvertent bolus to the patient when the occlusion is cleared.

\* \* \*

Use of an appropriate tubing set with a tamper resistant disk is highly recommended to ensure the integrity of the drug stored in the syringe.

\* \* \*

To reduce the risk of bolus being infused after an occlusion has occurred, the pressure must be relieved by resetting the pusher block and/or disconnecting the system prior to freeing the occlusion. To minimize the bolus volume, use disposable sets specifically designed for PCA pumps.

\* \* \*

Use only properly grounded electrical outlets with the AC adapter.

\* \* \*

Failure to plug the charger in promptly once the insert charger message has appeared may result in interruption of pump operation.



## Requesting Additional Information

For additional information, call  
Baxter Anesthesia at 1-800-343-0366.

To report problems, call 1-800-437-5176.

When reporting problems, please be prepared with the following information:

- Your name and title
- The name, address and phone number of the user facility
- Product catalog number(s)
- Serial or lot numbers(s)
- Was product in use on a patient when problem was detected?
- Was there any injury to the patient? (If yes, FDA user reporting may be required).
- Date of event
- Description of event (please include pump set-up, programming, configuration, and any alarms prior to or at the time of the event).

## This Infusion Pump is Subject to Tracking

Pursuant to Title 21 of the U.S. Code of Federal Regulations, Part 821, "Medical Device Tracking Requirements," customers within the United States have certain obligations in furthering the tracking of Infusion Pumps.

You should verify equipment serial numbers against those listed on the packing slip. If correct, indicate this on the packing slip by signing and dating the slip. Should any of the information be incorrect, please contact us at 1-800-THE-PUMP. To facilitate future communications, in addition to your signature, please print your name, title and telephone number on the packing slip. Return a copy of the packing slip to Baxter Healthcare, IV Systems Division.

Any format of verification that provides the required level of information is acceptable.

Infusion pump tracking within the hospital (or other types of user facilities) is not required. Please refer to page 43453 of the rule for further information. However, should you allocate any of your facility's infusion pumps for home patient use, you have additional tracking requirements. You must maintain a current patient and physician registry, by serial number, in a format that can be provided to the manufacturer within 5 working days. Should you sell a pump to a patient, you must promptly provide us with the patient and physician information.

The final rule on device tracking clarifies the responsibility of hospitals and other user facilities within the United States. The following Fact Sheet summarize these requirements. We would recommend that you develop written procedures that outline your operation's device tracking compliance plan.



## Infusion Pump Medical Device Tracking Fact Sheet

### 1. Scope

Per 21 CFR Part 821, infusion pumps have been categorized by the FDA as devices which must be tracked. If used within a device user facility (i.e., hospital, nursing home), tracking *to the user facility* is required. If the infusion pump is used outside a device user facility, the distributor who provides the device to a patient must keep records of the infusion pump's location and subsequently report this information to the manufacturer.

### 2. Effective Date

August 29, 1993

### 3. Definitions

User Facility	Hospital, Nursing Home, Ambulatory Surgical Facility, or Diagnostic Facility
Distributor	Any entity who furthers the distribution of a device from the original place of manufacture to the person who makes delivery or sale to the ultimate user, i.e., the final or multiple distributor, but who does not repackage or otherwise change the container, wrapper or labeling of the device or device package
Final Distributor	Any entity who distributes a tracked device intended for use by a SINGLE patient over the useful life of the device.
Multiple Distributor	Any entity that distributes a tracked device intended for use by MORE THAN ONE patient over the useful life of the device.

4. Distributors (consignees) are required to **REPORT TO THE MANUFACTURER** the purchase, receipt in trade, return after sale, loss, destruction or retirement of any tracked medical device.

Required Information:

- Name and address of the distributor (consignee)
- Model and serial or lot number of the device
- Date the device was received
- From whom the device was received
- Date of permanent distribution, i.e., loss, destruction, retirement

5. Upon **DISTRIBUTION OF A TRACKED DEVICE FOR USE IN OR BY THE HOME PATIENT**, the following record must be maintained by the distributor (final or multiple distributor who places the device in the home environment) for the useful life of the tracked device. Note useful life is defined as the time a device is in use or in distribution channels for use.

Required Information:

- Model and serial or lot number of the device
- Patient's name, address and telephone
- Date the device was provided to the patient
- Prescribing physician's name, address and telephone
- Attending physician's name, address and telephone

## 6. Reporting Requirements

The following information must be reported:

DATA	TIME FRAME ALLOWED TO OBTAIN INFORMATION
Manufacturer's distribution /inventory records	3 working days
Final distributor's patient and physician records	Reported to the manufacturer promptly following distribution to the patient
Multiple distributor's patient and physician records	Upon request, reported to the manufacturer within 5 working days
Manufacturer's patient records	10 working days (for multiple patient use devices such as Infusion Pumps), i.e. multiple distributor's registries

## 7. Audit Requirements

In addition, a statistically relevant sample of the manufacturer's consignees must be audited every 6 months for the first three years, then annually, to ensure compliance with tracking regulations. Customers who are not complying with this regulation must be reported to the FDA.

0

0



0

0

0

0

0



0

0

0

0

0

0

0

0

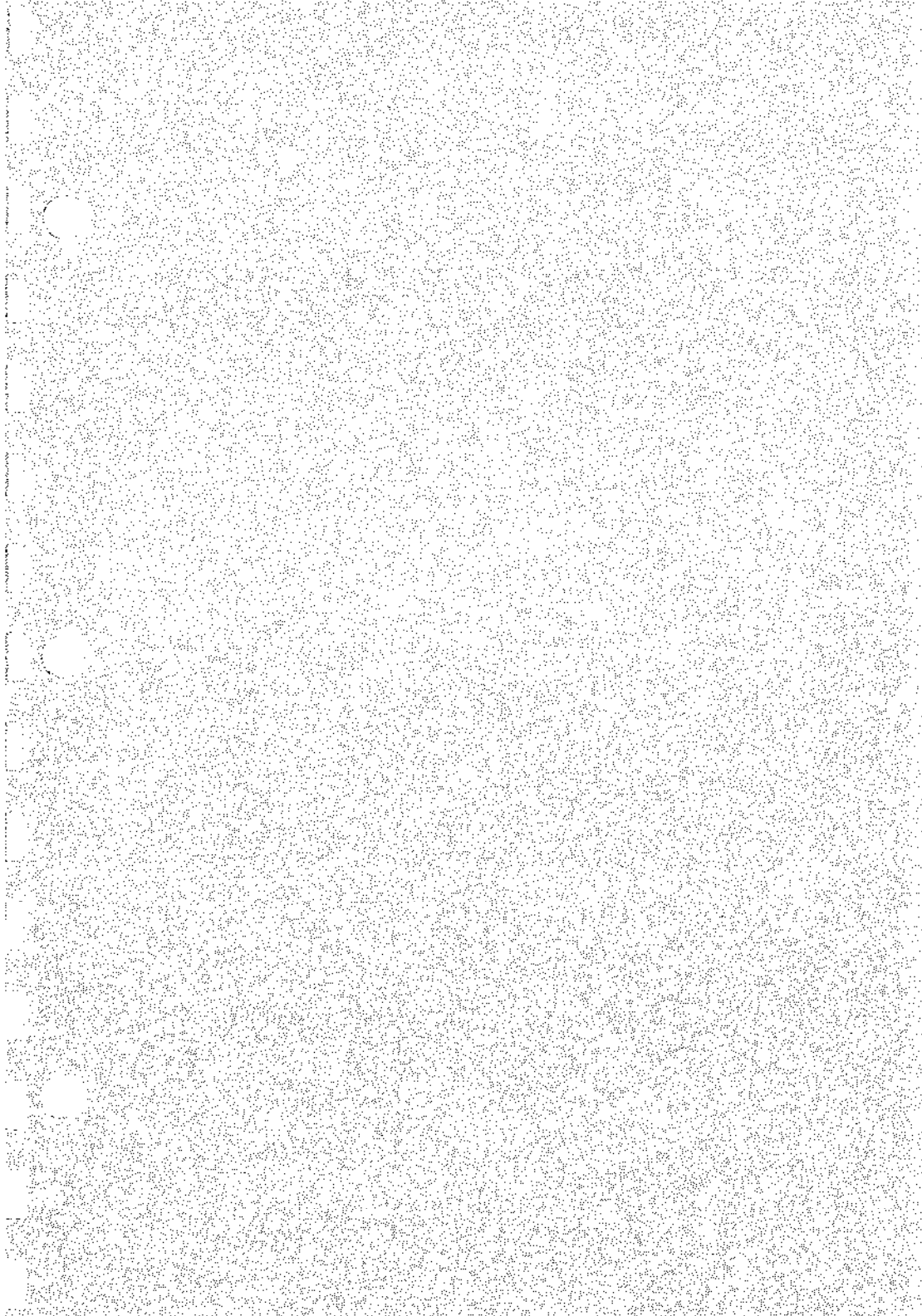

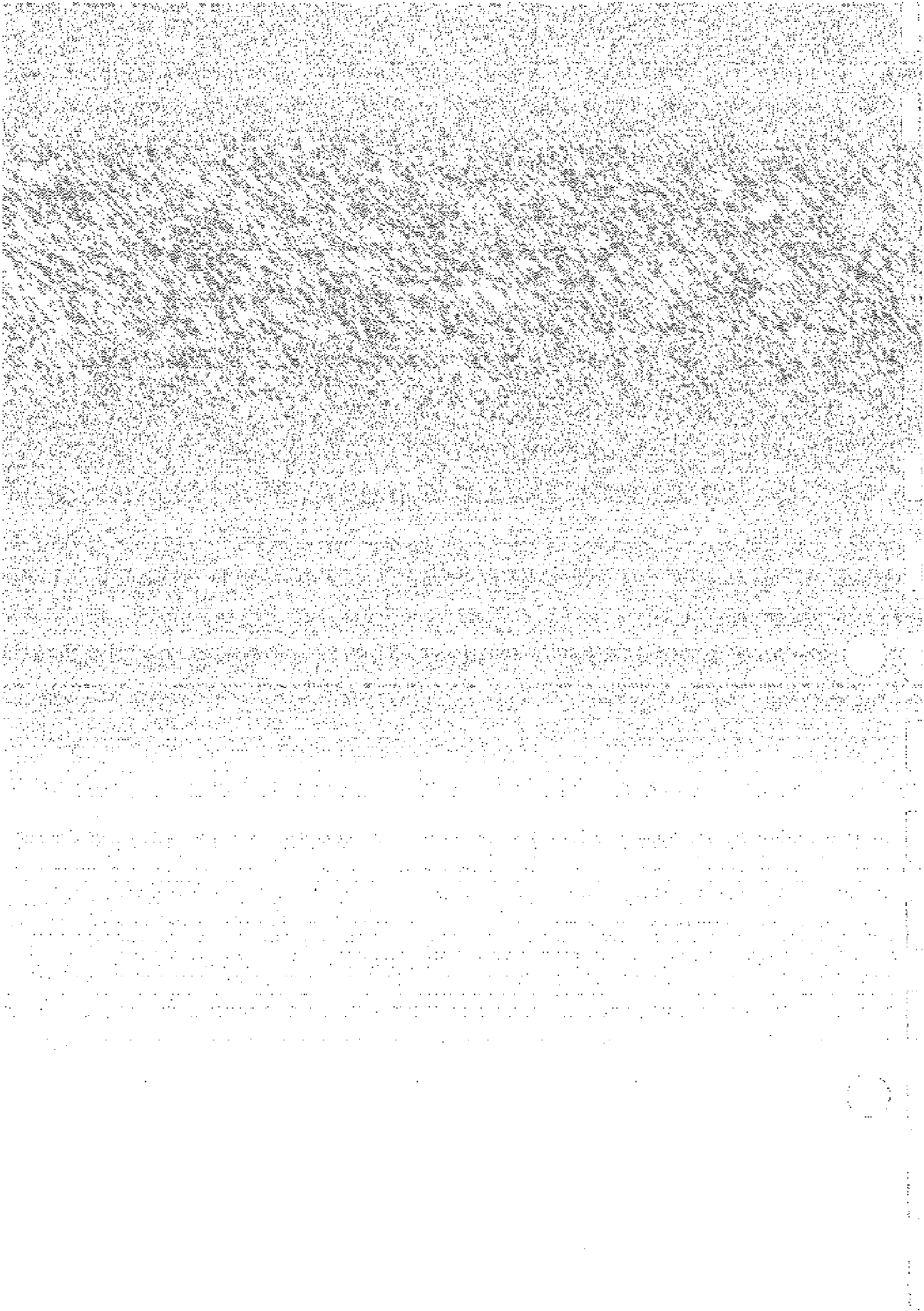

To Purchase, Visit [Avobus.com](http://Avobus.com) or call [1-800-674-3655](tel:1-800-674-3655)



## Index

- AC adapter connection point, 1-1, 3-2
- AC power kit, 3-1
- accuracy, 5-2
- alkaline batteries, 2-3, 4-2
- attaching the AC adapter, 3-2
- attaching the patient switch, 2-5
- attaching the pump to the pole, 2-4
- Attention light, 1-1, 1-2
- barrel flange, 2-7
- batteries
  - alkaline, 2-3, 4-2
  - rechargeable, 3-1
- battery compartment cover, 1-1, 2-3
- battery life, 5-3
- button
  - 0-9 decimal point, 1-2
  - CLEAR, 1-1, 1-2
  - ENTER, 1-1, 1-2
  - HISTORY, 1-1, 1-2
  - START/STOP, 1-1, 1-2
- cartridge connection point, 1-1
- cartridge label, 2-11
- checks
  - Attention light, 4-5
  - power-up, 4-5
  - pusher block, 4-5
  - syringe holder, 4-7
- cleaning and disinfecting, 4-3
- CLEAR button, 1-2
- compartment cover, battery, 1-1, 2-3
- components
  - AC adapter connection point, 3-2
  - battery compartment door, 1-1, 2-3
  - cartridge connection point, 1-1
  - front panel, 1-1
  - patient switch connection point, 1-1
  - pole connection point, 1-1
  - printer connection point, 1-1
  - syringe cover, 1-1
  - syringe holder, 1-1
- control panel, 1-2, see also fold out
  - illustration
- controls and indicators
  - Attention light, 1-1, 1-2
  - CLEAR button, 1-1, 1-2
  - ENTER button, 1-1, 1-2
  - HISTORY button, 1-1, 1-2
  - number and decimal keys, 1-2
  - OFF button, 1-1, 1-2
  - ON button, 1-1, 1-2
  - Power light, 1-2
  - START/STOP button, 1-1, 1-2
  - syringe cover lock, 1-2
- ENTER button, 1-1, 1-2
- entering the prescription, 2-14
- flange, syringe barrel, 2-7
- flow rates, 5-2
- front panel controls
  - HISTORY button, 1-1, 1-2
- indicators, 1-2, 5-2
- inserting batteries into the pump, 2-3
- installing a cartridge, 2-10
- installing the syringe, 2-7
- items needed to set up the pump, 2-1
- label, cartridge, 2-11
- lever release, 2-9
- light
  - Attention, 1-2
  - Power, 1-2
- lockable IV pole clamp, 2-5
- lubrication, 4-3
- maintenance, routine, 4-1
- messages, 3-3
- number and decimal keys, 1-2
- occlusion force, 5-2
- patient switch connection point, 1-1
- pole connection point, 1-1, 2-4
- power light, 1-2
- power kit, AC, 3-1
- power OFF switch, 1-1, 1-2
- power ON switch, 1-1, 1-2
- power-up, 2-12

- prefilled syringe, 2-6
- preparing
  - syringe, 2-6
  - tubing set, 2-6
- pressure, occlusion, 5-2
- priming, tubing set, 2-14
- printer connection point, 1-1
- printer, thermal, 2-16
- pusher block, 2-7
- rechargeable batteries, 3-1
- repair, 5-1
- replacing the batteries, 4-2
- routine maintenance, 4-1
- security features, 5-2
  - lockable IV pole clamp, 2-5,
  - locking syringe cover, 1-2
- Seiko thermal printer, 2-16
- service checks
  - Attention light, 4-5
  - power-up, 4-5
  - pusher block, 4-5
  - syringe holder, 4-7
- setting up the printer, 2-16
- setting up the pump, 2-1
- specifications, 5-2
- START/STOP button, 1-1, 1-2
- switches, ON, OFF, 1-1, 1-2
- syringe
  - B-1)<sup>®</sup> 60 mL plastic syringe, 2-6
  - 50 mL Prefilled Syringe prefilled, 2-6
  - Monoject<sup>®</sup> 60 mL plastic syringe, 2-6
  - tamper-resistant disk, 2-6
- syringe cover, 1-1
- syringe cover lock, 1-2
- syringe holder, 1-1
- syringe types, 2-6
- troubleshooting, 5-1
- tubing set
  - Anti-Siphon Set, 2-6
  - Combination Y-Set, 2-6
  - Prefill Combination Y-Set, 2-6
  - Tamper-Resistant Extension set, 2-6
  - weight, 5-3





1  
2  
3  
4  
5  
6  
7  
8  
9  
10  
11  
12  
13  
14  
15  
16  
17  
18  
19  
20  
21  
22  
23  
24  
25  
26  
27  
28  
29  
30  
31  
32  
33  
34  
35  
36  
37  
38  
39  
40  
41  
42  
43  
44  
45  
46  
47  
48  
49  
50  
51  
52  
53  
54  
55  
56  
57  
58  
59  
60  
61  
62  
63  
64  
65  
66  
67  
68  
69  
70  
71  
72  
73  
74  
75  
76  
77  
78  
79  
80  
81  
82  
83  
84  
85  
86  
87  
88  
89  
90  
91  
92  
93  
94  
95  
96  
97  
98  
99  
100

Open to see pump components

6

U



S

S

R

E

I



T

E

R

T

E

I

T

## **Baxter Healthcare Corporation Limited Warranty**

Baxter Healthcare Corporation warrants to the original purchaser that this Baxter product will be free from defects in material and workmanship for a period of one (1) year from the date of its shipment from Baxter to the original purchaser. If this product proves to be so defective, purchaser may return same to Baxter for repair or replacement, at Baxter's option. All returns must be authorized in advance in accordance with Baxter's Returned Goods Policy found in its then current Price List. The liability of Baxter under this limited product warranty does not extend to any abuse or misuse of this product or its repair by anyone other than an authorized Baxter representative.

THIS LIMITED PRODUCT WARRANTY IS IN LIEU OF ALL OTHER WARRANTIES, WHETHER EXPRESS OR IMPLIED, INCLUDING ANY WARRANTY OF MERCHANTABILITY OR FITNESS FOR A PARTICULAR PURPOSE.

THE LIABILITY AND REMEDY STATED IN THIS LIMITED PRODUCT WARRANTY WILL BE THE SOLE LIABILITY OF BAXTER AND REMEDY AVAILABLE TO PURCHASER FOR THIS PRODUCT, WHETHER IN CONTRACT, TORT, OR OTHERWISE, AND BAXTER WILL NOT BE LIABLE TO PURCHASER FOR ANY INCIDENTAL OR CONSEQUENTIAL DAMAGE ARISING OUT OF ITS HANDLING AND USE.

U  
S  
E  
R  
M  
A  
N  
U  
A  
L  
O  
F  
T  
H  
E  
A  
V  
O  
B  
U  
S  
E  
Q  
U  
I  
P  
M  
E  
N  
T



To Purchase, Visit [Avobus.com](http://Avobus.com) or call [1-800-674-3655](tel:1-800-674-3655)

1911

1912

1913



1914

1915

1916

1917

1918



1919

1920

1921

1922

1923



1924

1925

Anesthesia Division

**Baxter**

Baxter Healthcare Corporation  
Deerfield, IL 60015



To Purchase, Visit [Avobus.com](http://Avobus.com) or call [1-800-674-3655](tel:1-800-674-3655)